



SPOT 575 MB

coemar

manuale
di istruzioni
instructions
manual

1[^] edizione, giugno 2004
1st edition, june 2004

iSPOT 575 MB

numero di serie/serial number

data di acquisto/date of purchase

fornitore/retailer

indirizzo/address

cap/città/suburb

provincia/capital city

stato/state

tel./fax/

Prendete nota, nello spazio apposito, dei dati relativi al modello e al rivenditore del vostro **iWASH 575 MB**: in caso di richiesta di informazioni, pezzi di ricambio, servizi di riparazione o altro ci permetteranno di assistervi con la massima rapidità e precisione.

Please note in the space provided above the relative service information of the model and the retailer from whom you purchased your **iSPOT 575 MB**: This information will assist us in providing spare parts, repairs or in answering any technical enquiries with the utmost speed and accuracy.

ATTENZIONE: la sicurezza dell'apparecchio è garantita solo con l'uso appropriato delle presenti istruzioni, pertanto è necessario conservarle.

WARNING: the fixtures warranty is valid only if these instructions are strictly followed; therefore it is absolutely necessary to keep this manual.

Index

1. Packaging	Pag. 5
2. Transportation	„ 5
3. Important safety information	„ 5
4. Lamp: installation and substitution	„ 6
5. Operating voltage and frequency	„ 7
6. Installation	„ 8
7. Mains connection	„ 9
8. Signal connection	„ 10
9. Powering up	„ 11
10. DMX addressing	„ 12
11. Display panel functions	„ 13
11.1. Function setting (FUNC)	„ 13
11.2. Measure and test (MEAS)	„ 15
11.3. Quick guide to menu navigation	„ 16
11.4. Rapid scrolling	„ 16
12. DMX 512 operation	„ 17
13. Aligning the lamp in the optical path	„ 19
14. Turning on the iSPOT 575 MB without articulated movement	„ 20
15. Resetting the counter	„ 20
16. Automatic repositioning functions	„ 20
17. Opening up the projector	„ 21
18. Interchanging gobos	„ 22
19. Altering the operating voltage (Reserved for technical staff)	„ 23
19.1. Selecting the operating voltage	„ 23
20. Thermal protection	„ 24
21. Lamp circuit protection	„ 24
22. Maintenance	„ 24
23. Electronic motor alignment	„ 25
24. Error messages	„ 26
25. Spare parts	„ 27
26. Troubleshooting	„ 28'

Congratulations on having purchased a **coemar** product. You are assured of a projector of the highest quality, both in the componentry used and in the technology. We reiterate our invitation for you to complete the information on the previous page to expedite any request for service information or spares (in case of problems encountered either during, or subsequent to, installation). This information will assist in providing prompt and accurate advice from your **coemar** service centre.

1. Packaging

Following the instructions and procedures outlined in this manual will ensure the maximum efficiency of this product for years to come.

Open the packaging and ensure that no part of the equipment has suffered damage in transit. In case of damage to the equipment, contact your carrier immediately by telephone or fax, following this with formal notification in writing.

packing list

Ensure the packaging contains:

- 1 **iSPOT 575 MB**
- 1 **instruction manual**
- 2 **cam-lock suspension devices**

2. Transportation

The **iSPOT 575 MB** should be transported in its original packaging or in a **coemar** approved flight case.

During transportation, the packaging should ensure that the articulated movement of the **iSPOT 575 MB** should be blocked.

3. Important safety information

Fire prevention:

1. **iSPOT 575 MB** utilises a Philips **575 MSD** or **575 MSR/2 lamp**; the use of any other lamp is not recommended and will null and void the fixtures warranty.
2. Never locate the fixture on any flammable surface.
3. The minimum distance from any flammable materials: 0,5 m.
4. The minimum distance from the closest illuminable surface: 2 m.
5. Replace any blown or damaged fuses only with those of an identical value. Refer to the schematic diagram if there is any doubt.
6. Connect the projector to the mains power via a thermal-magnetic circuit breaker.

Preventing electric shock:

1. High voltage is present in the internals of the unit. Isolate the projector from mains supply prior to performing any function which involves touching the internals of the unit, including lamp replacement.
2. For mains connection, adhere strictly to the guidelines outlined in section 7 of this manual.
3. The level of technology inherent in the **iSPOT 575 MB** necessitates the use of specialist personnel for all service applications; refer all work to your authorised **coemar** service centre.
4. A good earth connection is essential for proper functioning of the projector.
Never operate the unit without proper earth connection.
5. Do not locate the fixture in an exposed position, or in areas of extreme humidity. A steady supply of circulating air is essential.

Protection against ultraviolet radiation:

1. Never turn on the lamp if any of the lenses, filters, or the housing is damaged; their respective functions will only operate efficiently if they are in perfect working order.
Never look directly into the lamp when it is operating.

Safety:

1. The projector should always be installed with bolts, clamps, and other fixings which are suitably rated to support the weight of the unit.
2. Always use a secondary safety chain of a suitable rating to sustain the weight of the unit in case of the failure of the primary fixing point.
3. The external surfaces of the unit at various points may exceed 150°C. Never handle the unit until at least 10 minutes have elapsed since the lamp was turned off.
4. Always replace the lamp if any physical damage is evident.
5. Never install the fixture in an enclosed area lacking sufficient air flow; the ambient temperature should not exceed 35°C.
6. A hot lamp may explode. Always wait for at least 10 minutes to elapse after the unit has been turned off prior to attempting to replace the lamp.
Always wear suitable hand protection when handling lamps.

Protection rating against penetration by solids and liquids:

1. The projector is rated as an ordinary device. Its protection rating is IP 20

4. Lamp: Installation and replacement

The **iSPOT 575 MB** utilises a Philips 575 MSD or Philips 575 MSR/2 575W lamp with a GX 9.5 lampbase. The lamp is available from your **coemar** service centre:

Philips 575 MSD

coemar cod.	105215
power	575 w
luminous flux	43.000 lm
colour temperature	6000° K
base	GX 9,5
approximate lamp life	3000 hours

Philips 575 MSR/2

coemar cod.	105245/2
power	575 w
luminous flux	49.000 lm
colour temperature	7.200° K
base	GX 9,5
approximate lamp life	1000 hours

Attention

Disconnect mains prior to opening up the unit.

The fixture's internal temperature can reach 250° C after 5 minutes with a maximum peak of 350° C; ensure that the lamp is cold prior to attempting removal. The fixture should be allowed to stand and cool for 10 minutes prior to its removal.

Both MSR and MSD lamps are part of the mercury vapour family of discharge lamps and must be handled with great care. The lamps operate at high pressure, and the slight risk of explosion exists if operated over their recommended lamp life.

We recommend, therefore, that the lamp be replaced within the manufacturer's specified lamp life.

installing the lamp

- 1) Using a Philips head screwdriver, loosen the 2 screws (A) which affix the lamp assembly, located at the rear of the projector.
- 2) Remove the lamp assembly (B).

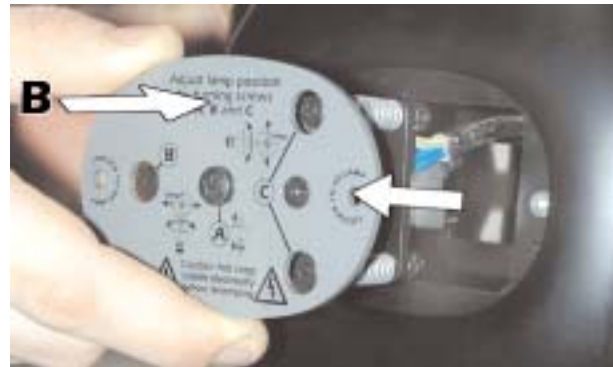
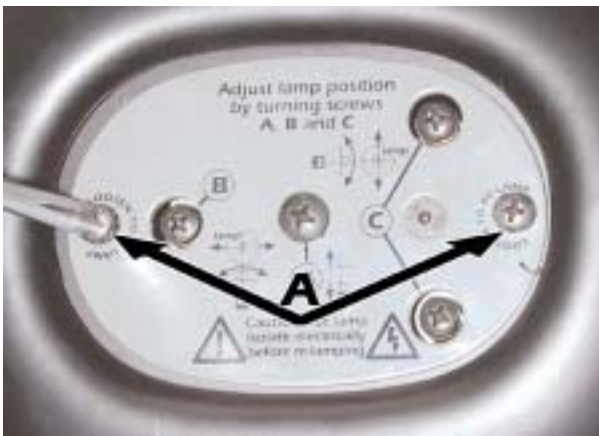

- 3) Locate the lampholder (C)

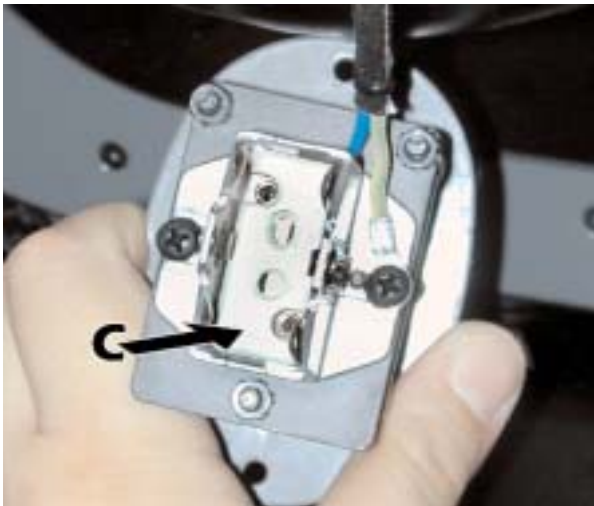

4) Insert the lamp.

The lamp is manufactured from quartz glass and should be handled with care; always adhere to the instructions supplied in the lamps packaging. Never touch the glass directly, use the tissue provided in the lamps packaging. The GX 9.5 lampholder is symmetrical in construction. **DO NOT USE UNDUE FORCE.** In case of difficulty, inspect for physical damage and then repeat the installation procedure.



5) Replace the lamp assembly into its original position and refasten the 2 screws (A) which were previously loosened.



Attention: we recommend that you realign the lamp in the optical system of the projector to optimise the output and to avoid damage to gobos and dichroics. Refer to section 13 for a description of this procedure.

5. Operating voltage and frequency

The projector is able to operate at either 100, 115, 208, 230 or 240 V. **Coemar** presets (barring specific requests) an operating voltage of 240v at a frequency of 50 Hz.

The operating voltage and frequency are noted on a sticker nearby the voltage selector on the base of the unit.

iSPOT 575 MB can operate at either 50 or 60 Hz with no need for any adjustments.

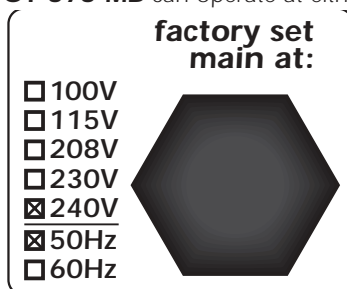

altering the operating voltage

If the preset voltage does not correspond with the conditions in your particular country of operation, follow the instructions in the appropriate section of this manual, section **15. Altering the operating voltage.**

Incorrect voltage selection will detrimentally affect the operation of the projector and will immediately void the warranty.

6. Mechanical installation

installation

iSPOT 575 MB may be suspended or floor mounted.

For the purposes of floor mounting, the **iSPOT 575 MB** is fitted with four pads on the base. For suspending the fixture from lighting truss, **coemar** has included two cam-lock devices (**A**).

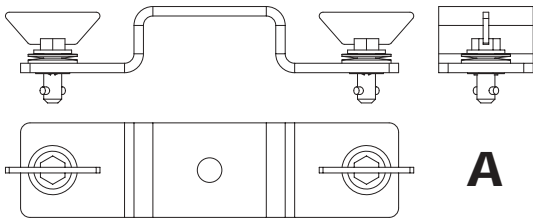

The two cam-lock devices may be installed on the base of the **iSPOT 575 MB**. The devices are 1/4 turn locking. To install them, make sure that they are correctly seated in the appropriate slots in the base of the unit.

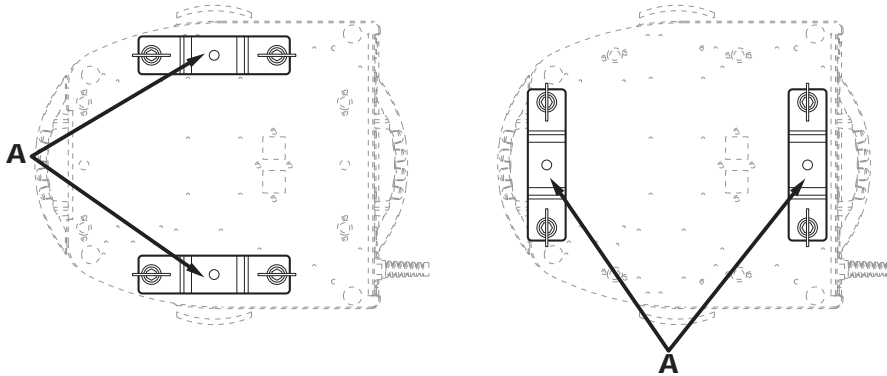

If the fixture is to be suspended, we recommend the use of appropriate C clamps which are capable of comfortably sustaining the weight of the fixture. The C-clamps are fitted to the central shaft of the cam-lock devices.

Attention

Always use 2 clamps to suspend the projector

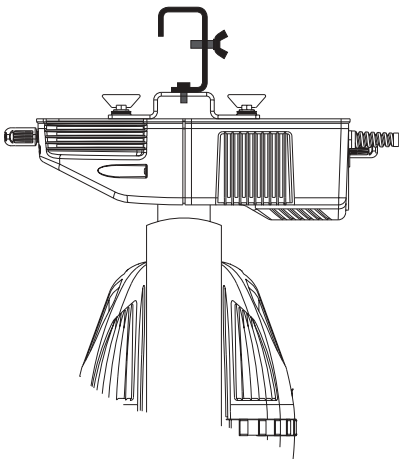

The structure from which the unit is hung should be of sufficient rating to hold the weight of the unit and should also be sufficiently rigid so as to not move or shake whilst the **iSPOT 575 MB** moves during its operation.

safety chains

The use of a safety chain fixed to the unit and to the primary suspension structure is highly recommended to protect against the accidental failure, however unlikely, of the primary suspension points.

If using an after-market safety chain not manufactured by coemar, ensure that it is of a sufficient rating to hold the weight of the unit. The safety chain is attached by means of the two holes B located in the base of the unit as shown in the diagram.

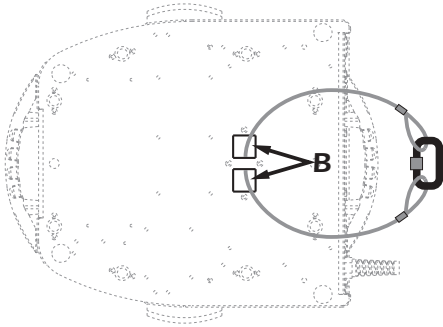

protection against liquids

The projector contains electric and electronic components that must not come into contact with water, oil, or any liquid.

movements

The projector has an articulated movement of 360° in the base and 252° through its yoke; DO NOT obstruct the articulated movement in any way.

risk of fire

Each fixture produces heat and must be installed in a well-ventilated position. The minimum recommended distance from flammable material is: 0.5m. Minimum distance from the object being illuminated is: 2m.

forced ventilation

You will note that the projector contains several cooling fans and vents located in the base and the yoke. Under no circumstances should these be obstructed.

Obstruction of any of these points will result in the over-heating of the unit, detrimentally and seriously affecting the proper operation of the fixture.

ambient temperature

Never install the projector in locations where there is insufficient flow of circulating air; the ambient temperature should not exceed 35°C.

7. Mains connection

preparing the cable

The mains cable provided is thermally resistant, having VDE approval and complying to the most recent international standards, namely IEC 331, IEC 332 3C, CEI 20 35.

NB: In case of cable replacement, similar cable with comparable thermal resistant qualities must be used exclusively (cable 3x1,5 ø external 10 mm, rated 300/500V, tested to 2KV, operating temperature -40° +180°, **coemar** cod. CV5309).

mains connection

iSPOT 575 MB may operate at 100V-115V-208V-230V-240V at 50 or 60Hz (operating voltage should be selected as discussed in section 5 of this manual). Prior to connecting the unit to your mains supply, ensure that the model in your possession correctly matches the mains supply available to you. For connection purposes, ensure that your plug is of a suitable rating: : 4.5 amps at 230V, 8 Amps at 115 V. Locate the mains cable which exits the base of the unit and connect as shown below:

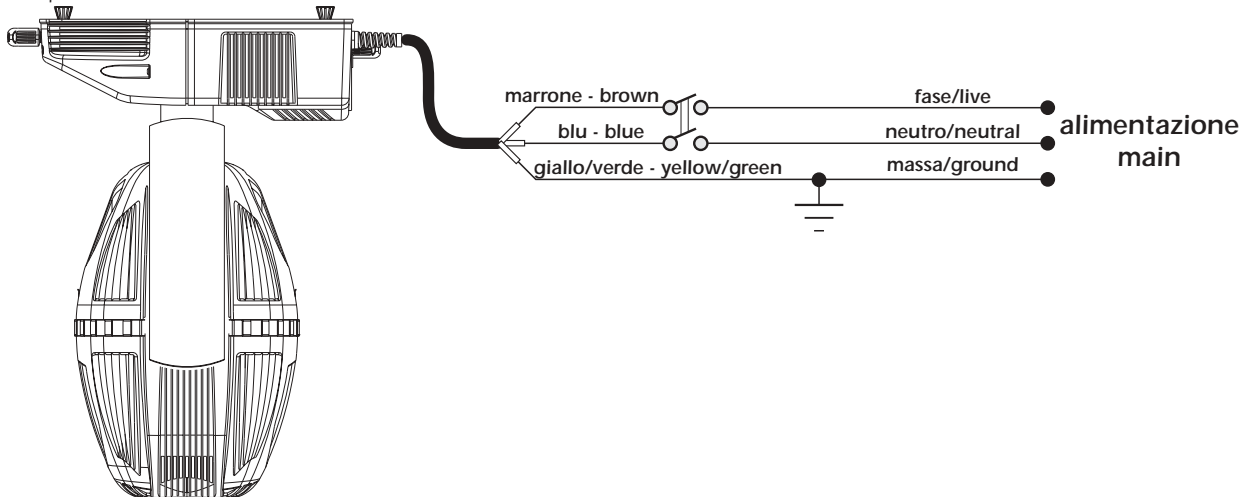

protection

The use of a thermal magnetic circuit breaker is recommended for each **iSPOT 575 MB**.

A good earth connection is essential for the correct operation of the fixture. Strict adherence to regulatory norms is strongly recommended.

8. Signal connection

Control signal is digital and is transmitted via two pair screened $\varnothing 0,5$ cable. Connection is serial, utilising XLR 3 male and female sockets on the base of the **iSPOT 575 MB**, labeled **DMX 512 In** and **Out** (see diagram).

Pin connection conforms to international standards:

- pin 1= screening 0 volt
- pin 2= data -
- pin 3= data +

Should your DMX 512 controller utilise only XLR 5 sockets, pins 4 and 5 should not be connected.

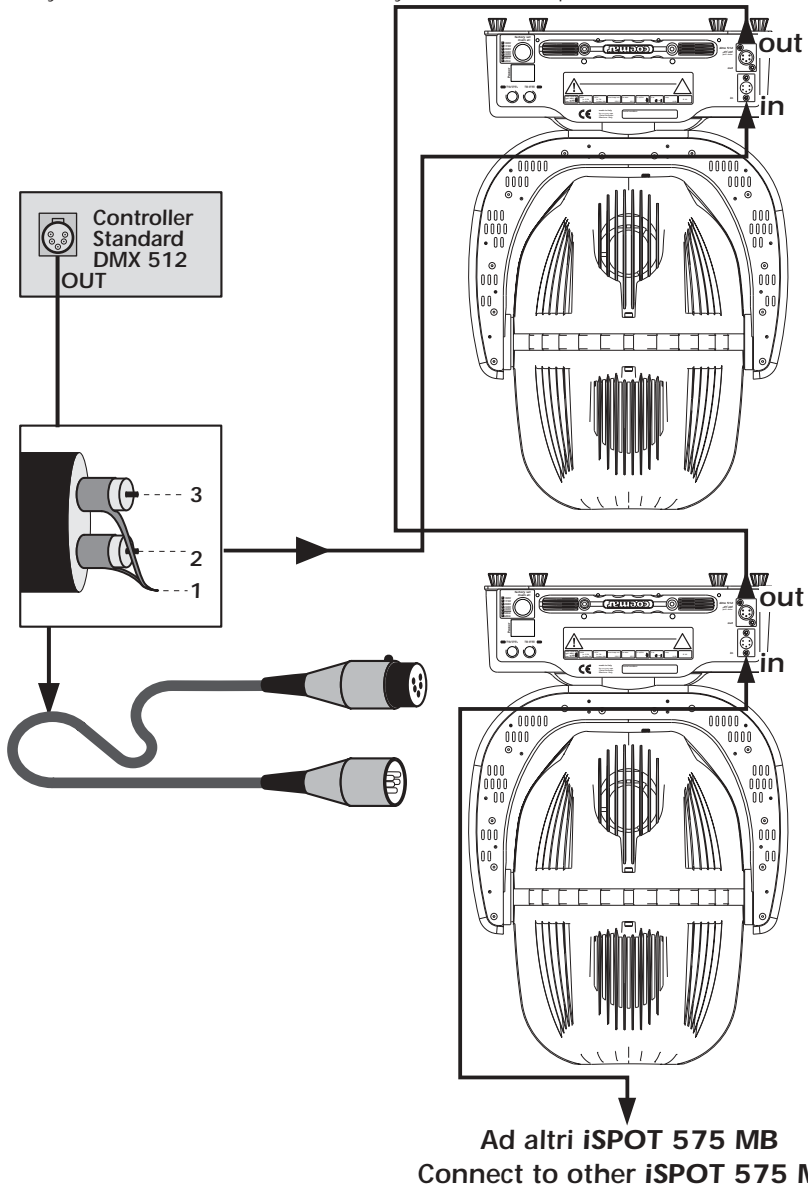

Ensure that all data conductors are isolated from one another and the metal housing of the connector.

Note: the housing of the cannon XLR 3 or 5 must be isolated

9. Powering up

After having followed the preceding steps, turn on the projector via the **power** button. Upon powering up, the projector will perform a reset on all its motors, allowing them to be correctly aligned.

Software version

Three software systems are located within the projector, located in the display pcb "**D**" and the master pcbs "**A**" and "**B**". Upon powering up, the display of the projector will for a few seconds show the software versions installed in the unit. For example, the **Ispot 575 MB** may show:

D1.10 (display software "**D**" version 1.10.)

A1.02 (master software installed in location "**A**" version 1.02.)

B1.01 (master software installed in location "**B**" version 1.01.)

DMX reception

After having displayed the software versions, the projector will perform a reset and, following this, the display will stay on in a fixed mode, indicating that the fixture is correctly receiving **DMX 512** signal.

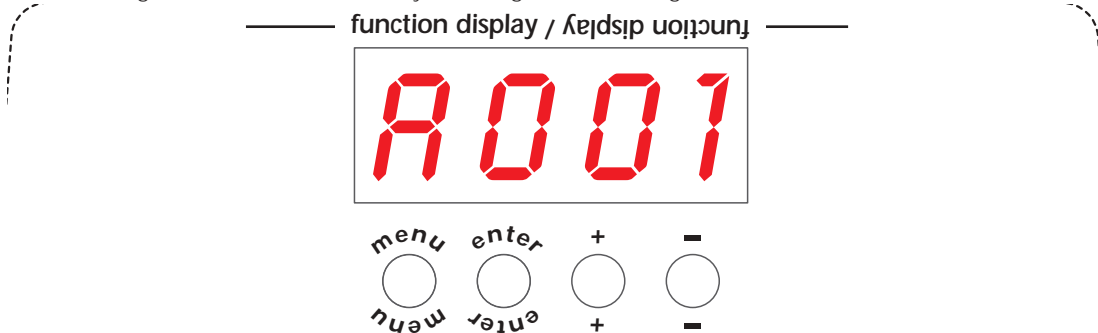

If the display flashes, the projector is not receiving signal. Check the operation of your controller and your cabling.

turning on the projector with no dmx signal present

After having displayed the software versions, the projector will perform a reset and, following this, the display will flash, indicating that the fixture is not receiving **DMX 512** signal.

10. DMX addressing

Each projector utilises **22 channels of DMX 512 signal for complete control** (see section **12. DMX 512 signal functions for more comprehensive information**)

DMX addressing

To ensure that each projector accesses the correct signal, it is necessary to correctly address each fixture. Any number between 1 and 490 can be generated via the multifunction panel of the **iSPOT 575 MB**.

This procedure must be carried out on every **iSPOT 575 MB**.

When initially powered up, each projector will show **A001** which indicates **DMX** address **1**; a projector thus addressed will respond to channels **1** to **22** of your **DMX 512 controller**. A second projector should be addressed as **23**, a third as **45** and so on until the final **iSPOT 575 MB**, in relation to the number of channels addressable by your controller.

altering the dmx address

- 1) Press the **+** or **-** button until the required **DMX** address is located. The display panel will flash, indicating that the currently displayed address is not recorded.

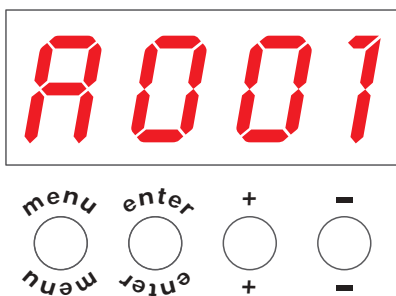

- 2) Press the **enter** button to confirm your selection; the display panel will stop flashing and the fixture will now respond to the newly assigned **DMX 512** address.
- 3) To gain an understanding of the functions of each channel of **DMX 512**, we recommend that you read section **12. DMX 512 operation**

Important Note: holding down the **+** or **-** buttons will cause the display to scroll quickly through the channel numbers at an increased speed, allowing a faster selection to be effected.

11. Display panel functions

By using the display panel located on the **iSPOT 575 MB** you are able to display and set function information and to alter various configuration parameters.

Incorrectly altering the **coemar** factory settings may vary the functioning of the projector, causing it to not respond to external DMX 512 control signal; please read and familiarise yourself with the following information very carefully prior to altering any selections.

NOTE: the  symbol is used in the following table to indicated the action of pressing the appropriately labeled button.

11.1. Function settings (FUNC)

The projector is able to have several function settings altered in order to personalise its use to your requirements.

R001

 menu

FUNC functions menu

The unit gives the possibility to vary some functions settings and to apply personalizations.

 enter

 +/-	PD IR pan movement inversion To reverse horizontal movement direction of the beam on DMX level variation.	 enter	 +/-	CW clockwise	 enter
			 +/-	CCW counter-clockwise	 enter
 +/-	TD IR tilt movement inversion To reverse vertical movement direction of the beam on DMX level variation.	 enter	 +/-	CW clockwise	 enter
			 +/-	CCW counter-clockwise	 enter
 +/-	OPTO optic sensor de-activation To deactivate the optic sensor function with return in position of the unit if accidentally knocked out of place.	 enter	 +/-	ON sensors activation	 enter
			 +/-	OFF sensors deactivation	 enter
 +/-	LAMP lamp control To disable on/off control of the lamp by DMX signal	 enter	 +/-	STRD switching on through DMX 512	 enter
			 +/-	ON lamp always on	 enter
 +/-	FANS fans control Fans status control through PCB (Strd) or fans always on (On).	 enter	 +/-	STRD fans speed control depending on external temperature and lamp status	 enter
			 +/-	ON fans always on	 enter
 +/-	DISP reverse display To reverse the display reading depending on mounting position (base or suspended)	 enter	 +/-	AA base downwards	 enter
			 +/-	BB reversed, base upwards	 enter
 +/-	LED display control To disable display visualisation.	 enter	 +/-	OFF to switch the display off ( any keys to switch it on)	 enter
 +/-	RESE reset Reset function.	 enter	 +/-	--- reset activation	 enter
 +/-	DFSE default functions setting to set all the functions at the original values, but for the alignment operations and for the recorded programs.	 enter	 +/-	SURE flashing	 enter
 +/-	DEMO demo program To see all the units functions dell'apparecchio.	 enter	 +/-	--- demo program activation	 enter
 +/-	IRIS iris iris function mode	 enter	 +/-	LIN linear iris	 enter
			 +/-	OFF pulse iris	 enter
 +/-	X.Y Pan and Tilt setting Function without pan/tilt movement	 enter	 +/-	LIN linear iris	 enter
			 +/-	OFF pulse iris	 enter
 +/-	PAN Pan movment control Pan mode: reduction of angle rotation from 540° to 400°	 enter	 +/-	540 Pan 540°	 enter
			 +/-	400 Pan 400°	 enter
 +/-	SHUT Shutter setting 2 Different modes of shutter function	 enter	 +/-	MOD.1 mode 1	 enter
			 +/-	MOD.2 mode 2	 enter
 +/-	ID ID number setting To set the units ID number from 0(no ID, to 250).	 enter	 +/-	1-250 numeric value	 enter

inverted display

English

As stated in the table above, the **iSPOT 575 MB** is able to invert the display on the projector should it be installed base down. The display will appear as shown in the diagram below.

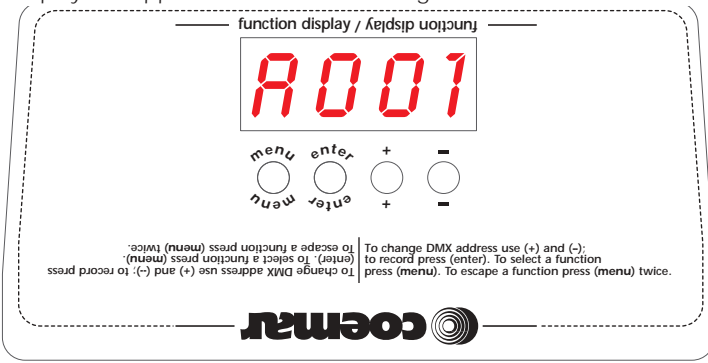

11.2. Measure and test (MEAS)

The electronic pcbs of the **iSPOT 575 MB** allow for various digital and auto-diagnostic measurements to be made. You may, in this section, record a home position to which the projector will return when it is turned on in the absence of dmx signal.

R001

menu

FUNC +/-	MEAS enter	TEST test	enter	PAN pan movement	enter	0/255 +/-
		function test				
			+/-	TILT tilt movement	enter	0/255 +/-
			+/-	DIMM dimmer activation	enter	0/255 +/-
			+/-	SHUT shutter activation	enter	0/255 +/-
			+/-	IRIS iris activation	enter	0/255 +/-
			+/-	STZO step zoom activation	enter	0/255 +/-
			+/-	FOCU focus activation	enter	0/255 +/-
			+/-	GOB1 gobo wheel 1 selection	enter	0/255 +/-
			+/-	GBP1 gobo 1 positioning	enter	0/255 +/-
			+/-	GBR1 gobo 1 rotation	enter	0/255 +/-
			+/-	GOB2 gobo wheel 2 selection	enter	0/255 +/-
			+/-	GBP2 gobo 2 positioning	enter	0/255 +/-
			+/-	GBR2 gobo 2 rotation	enter	0/255 +/-
			+/-	PRIS prisma activation	enter	0/255 +/-
			+/-	COL1 colour wheel 1 selection	enter	0/255 +/-
			+/-	COL2 colour wheel 2 selection	enter	0/255 +/-
			+/-	STOR	enter	SURE enter

to record the position of the unit and of its internal components. If DMX signal is not applied, the recorded setting will appear at the end of reset operation when the unit is switched on.

+/-	TEMP temperature	enter	58C
	to measure the internal temperature in C°		temperature measurement
+/-	VFAN voltage to fans	enter	13.8V
	to measure the DC voltage to the fans located in the unit. Values higher than 13,8V are anomalous.		voltage measurement
+/-	DMIN DMX value on each channel	enter	CH01 enter 10
	reading of DMX value (0/255), received by each of the 22 channels on DMX 512 line.		from channel 1 DMX value reading
		+/-	CH22 enter 255
			to channel 22 DMX value reading
+/-	RATE DMX rate	enter	24.50
	reading of DMX 512 signal value.		value reading
+/-	ALRM Alarm	enter	NO.AL
	Reading of Warning message sequences (errors) shown during reset operation		
		+/-	OPER
			to visualize other warning messages
+/-	HOUR working time	enter	LIFE enter 10
	working time (in hours)		lamp life after last reset value reading
			N.B.: reset the LIFE value when changing the lamp
+/-		enter	LIFS enter 589
			life of all lamps used on the unit value reading
+/-		enter	UNIT enter 1230
			projector life value reading

11.3. Quick guide to menu navigation

The following guide will allow you to scroll quickly through the various menus located in the display.

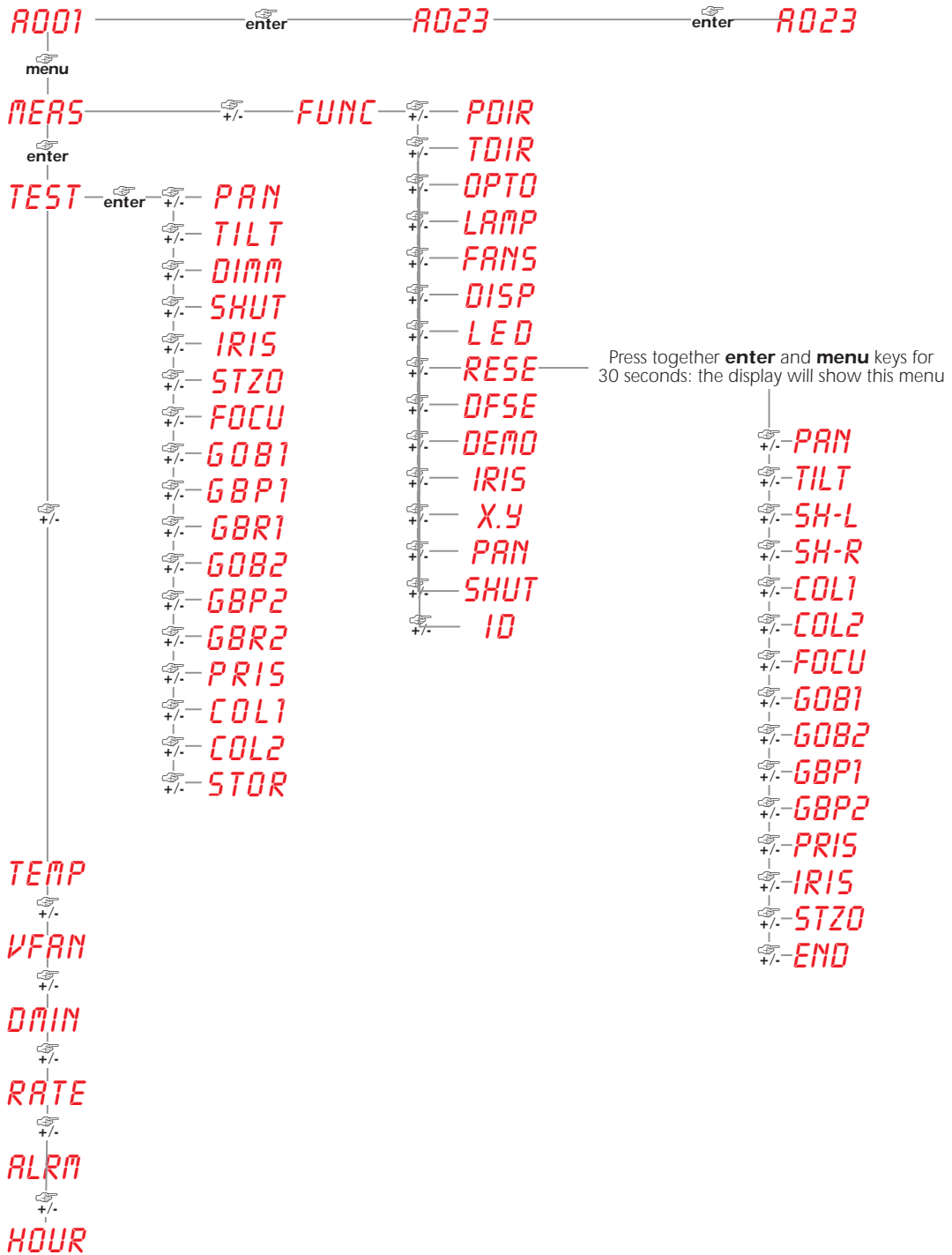

11.4. Rapid scrolling

Via the display of the **iSPOT 575 MB** it is possible to quickly alter the numerical values associated with the various parameter settings. There are three methods for doing this:

- 1) Pressing and holding the + or - buttons will cause the display to scroll rapidly in sequence through the numerical values.
- 2) Pressing and holding the + button and then pressing and holding down the - button will cause the display to jump to the highest possible value associated with the respective parameter.
- 3) Pressing and holding the - button and then pressing and holding down the + button will cause the display to jump to the lowest possible value associated with the respective parameter.

12. DMX 512 operation

If all the procedures have been carried out correctly to this point, the 22 channels of your **DMX 512** controller will have control over all the functions of the **iSPOT 575 MB** as described in the table below:

channel	function	type of control	effect	decimal	percentage	
1	X axis, base movement (pan)	proportional	control of the pan movement of the beam of light via proportional rotation of the base motor	0 - 255	0% - 100%	
2	X axis, fine base movement (pan)	proportional	fine control of the pan movement of the beam of light via proportional rotation of the base motor	0 - 255	0% - 100%	
3	Y axis, yoke movement (tilt)	proportional	control of the tilt movement of the beam of light via proportional rotation of the yoke motor	0 - 255	0% - 100%	
4	Y axis, fine yoke movement (tilt)	proportional	fine control of the tilt movement of the beam of light via proportional rotation of the yoke motor	0 - 255	0% - 100%	
5	movement speed	step	standard (fast)	0 - 10	0% - 4%	
		step	ultra fast movement (ideal for positioning during programming)	11 - 25	4% - 10%	
		proportional	vector mode (from fast to slow)	26 - 127	10% - 50%	
		proportional	Tracking mode (from fast to slow)	128 - 247	50% - 97%	
		step	Tracking mode (slow)	248 - 255	97% - 100%	
6	dimmer	step	closed	0 - 7	0% - 3%	
		proportional	adjust output intensity from 0 to 100%	8 - 255	3% - 100%	
7	shutter, strobe	step	shutter closed	0 - 9	0% - 4%	
		proportional	variable speed strobing effect, from slow to fast	10 - 66	4% - 26%	
		step	shutter open	67 - 68	26% - 27%	
		proportional	sequenced pulse effect, slow closing, fast opening (variable speed pulsing, from slow to fast)	69 - 125	27% - 49%	
		step	shutter open	126 - 127	49% - 50%	
		proportional	sequenced pulse effect, fast closing, slow opening (variable speed pulsing, from fast to slow)	128 - 184	50% - 72%	
		step	shutter open	185 - 187	73% - 73%	
		proportional	random strobe effect with variable speed from slow to fast	188 - 244	74% - 96%	
8	iris diaphragm (LIN-Linear)	step	open	0 - 9	0% - 4%	
		proportional	from maximum opening to minimum opening	10 - 255	4% - 100%	
NOTE 1: the iris diaphragm has different effects depending upon the settings made when selecting IRIS on the display (linear LIN or with internal effects PULS)						
8	iris diaphragm (with internal effects PULS)	step	open	0 - 9	0% - 4%	
		proportional	from maximum open to minimum	10 - 124	4% - 49%	
		step	minimum diameter	125 - 129	49% - 51%	
		proportional	pulse effect with proportional increase in speed	130 - 189	51% - 74%	
		step	open	190 - 192	75% - 75%	
proportional	pulse and flash effect with proportional increase in speed	193 - 255	76% - 100%			
NOTE 2: the iris focus lense is automatically inserted into the light beam when the iris channel is set to above 9 and no gobo has been selected; this automated feature can be disenabled by taking channel 22 to a level between 171 and 209						
9	step zoom channel 22 is between 171 and 209	step	iris focus	0 - 85	0% - 33%	
			21° lense	86 - 171	34% - 67%	
			25° lense	172 - 255	67% - 100%	
9	step zoom channel 22 is between 250 and 255	step	21° lense	0 - 127	0% - 50%	
			25° lense	128 - 255	50% - 100%	
10	focus	proportional	proportional control of focus	0 - 255	0% - 100%	
11	selecting rotating gobos wheel 1 (wheel closest to the lamp)	step or proportional selectable via channel 20	step	no gobo	0 - 10	0% - 4%
			gobo 1	11 - 40	4% - 16%	
			gobo 2	41 - 70	16% - 27%	
			gobo 3	71 - 100	28% - 39%	
			gobo 4	101 - 130	40% - 51%	
			gobo 5	131 - 160	51% - 63%	
			gobo 6	161 - 192	63% - 75%	
proportional	continuous rotation of the gobo wheel from slow to fast	193 - 255	76% - 100%			
12	indexing the rotating gobos (wheel 1) through 360°	step	no effect	0 - 10	0% - 4%	
		proportional	proportional positioning of the gobo on the wheel from 1 to 360°	11 - 255	4% - 100%	
13	rotating the gobos on wheel 1 and fine indexing control	proportional	fine indexing / accurate positioning of the gobo (if channel 12 is above a level of 10)	0 - 100	0% - 39%	
		proportional	continuous rotation of the gobo in an anti-clockwise direction with a proportional decrease in speed	101 - 176	40% - 69%	
		step	gobo stop	177 - 179	69% - 70%	
		proportional	continuous rotation of the gobo in a clockwise direction with a proportional increase in speed	180 - 255	71% - 100%	
14	selecting rotating gobos on wheel 2	step or proportional selectable via channel 20	step	no gobo	0 - 10	0% - 4%
			gobo 1	11 - 40	4% - 16%	
			gobo 2	41 - 70	16% - 27%	
			gobo 3	71 - 100	28% - 39%	
			gobo 4	101 - 130	40% - 51%	
			gobo 5	131 - 160	51% - 63%	
			gobo 6	161 - 192	63% - 75%	
proportional	continuous rotation of the gobo wheel from slow to fast	193 - 255	76% - 100%			
15	indexing the rotating gobos (wheel 2) through 360°	step	no effect	0 - 10	0% - 4%	
		proportional	proportional positioning of the gobo on the wheel from 1 to 360°	11 - 255	4% - 100%	
NOTE 4: when channel 15 is set to between 0 and 10, gobo rotation (channel 16) has no effect on indexing, the gobo stops instantaneously						

channel	function	type of control	effect	decimal	percentage
16	gobo rotation on wheel 2 and fine indexing control	proportional	fine indexing / accurate positioning of the gobo (if channel 15 is above a level of 10)	0 - 100	0% - 39%
		proportional	continuous rotation of the gobo in a clockwise direction with a proportional decrease in speed	101 - 176	40% - 69%
		step	gobo stop	177 - 179	69% - 70%
		proportional	continuous rotation of the gobo in an anti-clockwise direction with a proportional increase in speed	180 - 255	71% - 100%
17	selecting and rotating the prism	step	no effect	0 - 10	0% - 4%
		step	prism inserted into the light beam	11 - 20	4% - 8%
		proportional	continuous rotation of the prism in a clockwise direction with a proportional speed from maximum to minimum	21 - 136	8% - 53%
		step	stop the prism rotation	137 - 139	54% - 55%
		proportional	continuous rotation of the prism in an anti-clockwise direction with a proportional speed from minimum to maximum	140 - 255	55% - 100%
18	colour wheel 1 (closest colour wheel to lamp)	step	no colour, white beam	0 - 7	0% - 3%
		step or proportional selectable via channel 20	colour 1	8 - 27	3% - 11%
			colour 2	28 - 47	11% - 18%
			colour 3	48 - 67	19% - 26%
			colour 4	68 - 87	27% - 34%
			colour 5	88 - 107	35% - 42%
			colour 6	108 - 127	42% - 50%
		proportional	rainbow effect in a clockwise direction from fast to slow	128 - 190	50% - 75%
		step	no rotation	191 - 192	75% - 75%
proportional	rainbow effect in an anti-clockwise direction from slow to fast	193 - 255	76% - 100%		
19	colour wheel 2	step	no colour, white beam	0 - 7	0% - 3%
		step or proportional selectable via channel 20	colour 1	8 - 27	3% - 11%
			colour 2	28 - 47	11% - 18%
			colour 3	48 - 67	19% - 26%
			colour 4	68 - 87	27% - 34%
			colour 5	88 - 107	35% - 42%
			colour 6	108 - 127	42% - 50%
		proportional	rainbow effect in an anti-clockwise direction from fast to slow	128 - 190	50% - 75%
		step	no rotation	191 - 192	75% - 75%
proportional	rainbow effect in an anti-clockwise direction from slow to fast	193 - 255	76% - 100%		
20	gobo and colour positioning	step	Gobos and colours are centred in the optical path	0 - 10	0% - 4%
			Proportional positioning of gobos in the optical path	11 - 125	4% - 49%
			Proportional positioning of colours in the optical path	126 - 239	49% - 94%
			Proportional positioning of both gobos and colours in the optical path	240 - 255	94% - 100%
21	black-out activation synchronised with movement, colour and gobo selection	step	no effect	0 - 249	0% - 98%
			Black-out of the beam of light when PAN/TILT movement occurs or when colours and/or gobos change	250 - 255	98% - 100%
22	lamp on/off, resetting g motors and inhibiting automatic lense selection	step	park, no function	0 - 10	0% - 4%
			lamp off	11 - 29	4% - 11%
			pan and tilt reset (once only)	30 - 65	12% - 25%
			reset of all the motors with the exception of the dimmer, pan and tilt (once only)	66 - 100	26% - 39%
			reset of all the motors with the exception of the dimmer (once only)	101 - 135	40% - 53%
			reset of all the motors (once only)	136 - 170	53% - 67%
			disenables the automatic insertion of the iris lense (fans and lamp do not change functionality)	171 - 209	67% - 82%
			fans at maximum speed (only when lamp on)	210 - 249	82% - 98%
lamp on, fans off (if internal temperature allows)	250 - 255	98% - 100%			

Note 5: The display panel may be used to disable the switching off of the lamp via DMX

Note 6: Turning off the lamp and all the reset functions are delayed by 6 seconds to prevent accidental activation

Note 7: The lamp on/off function can only be effected if an opposite level is set

Projector: coemar i Spot 575 MB

Table name: DMX 512 functions

Table number: 224

Edition: 0

Date: 11/05/2004

13. Aligning the lamp in the optical path

Aligning the lamp in the optical path is achieved by altering the three adjusters located on the rear of the fixture.

This procedure should be undertaken to properly align the lamp in the optical system, thus avoiding the possible overheating of internal components and ensuring the maximum luminous output from the fixture.

aligning

Alignment is effected by operating the three adjusters **A**, **B** and **C** simultaneously with the lamp on, shutter and simmer open and no filters in place.

Output from a non-aligned lamp will be noticeable for a hot-spot; adjustment will bring the hot spot towards the centre of the beam (adjusters B and C), flattening it in the process (adjuster A).

Vertical adjustment

Adjuster (**C**) acts on an internal lever and spring assembly which moves the lamp vertically toward the centre of the parabolic reflector; rotate it until the correct positioning is achieved.

Horizontal adjustment

Adjuster (**B**) acts on an internal lever which moves the lamp horizontally in the centre of the parabolic reflector; rotate it until the correct positioning is achieved.

Axial adjustment

Adjuster (**A**) moves the entire lampholder assembly axially within the reflector, rotate it until a flat, even beam is produced, with no noticeable hotspot.

NB: It is extremely important to ensure that the beam is adjusted to its maximum uniformity avoiding hotspots which may result in damage to the gobos and dichroics.

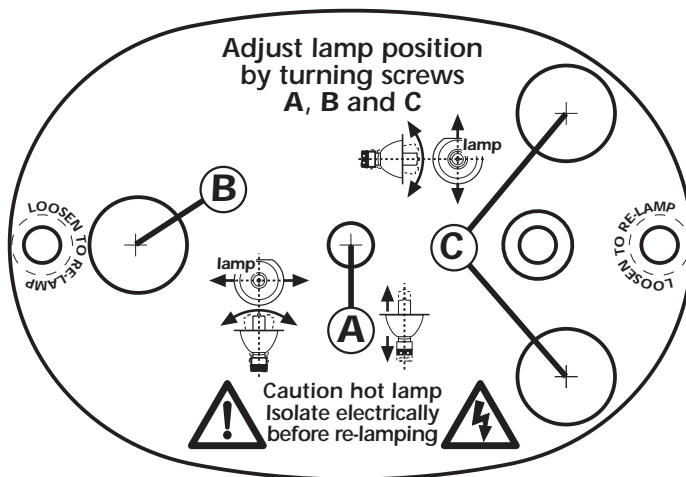

14. Turning on the iSPOT 575 MB without articulated movement

This procedure may be useful in situations where the **iSPOT 575 MB** may need to be switched on and have parameters altered in an enclosed space, such as in its flight case.

1) Turn on the projector whilst holding down the **enter**, **menu** and **-** buttons simultaneously.

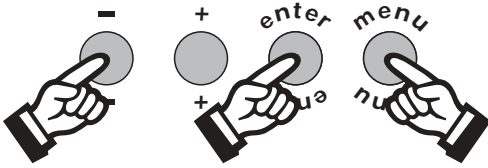

The projector will perform reset of its electronic systems without any motor movement.

2) You may alter the DMX address or any other parameter at this point without any articulated movement.

3) To return to normal operation of the **iSPOT 575 MB** turn the unit off and on via the **power** button, or effect a reset via the menu system.

15. Resetting the counters

The electronic counter should be reset every time a lamp is changed in the projector. so that realistic information about lamp life may be obtained. Upon turning on the **iSPOT 575 MB**, simultaneously press the **+** and **-** buttons. In this manner, the counter will be reset.

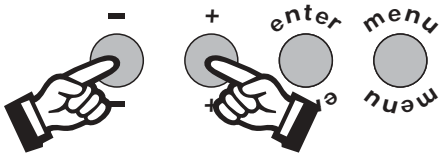

The procedure has reset the **LIFE** counter.

To verify that the procedure has taken place, undertake the following steps:

- 1) Press the **menu** button; the projector will show **FUNC**
- 2) Press the **+** or **-** buttons to show **MERS**.
- 3) Press the **enter** button
- 4) Press the **+** or **-** buttons to show **HOUR** (display in hours).
- 5) Press the **enter** button
- 6) Press the **+** or **-** buttons to show **LIFE** (for lamp life).
- 7) Press the **enter** button, the display will show **0000** confirming that the counter has been reset.

N.B. You may verify that the other counters **LIFS** (for total lamp life of all lamps utilised) and **UNIT** (operating life of the projector) have not been reset.

16. Automatic repositioning feature

An encoder system based on 4 position indicators allows the **iSPOT 575 MB** to return to its correct position if it is accidentally moved during operation.

This is particularly useful if the projector is to be mounted on the floor in a position where the performer or artist may accidentally bump the unit.

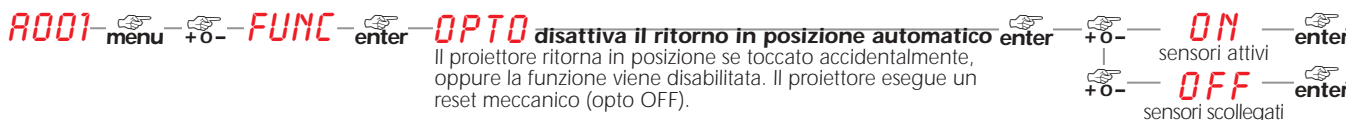

NOTE: this function may be disabled (display panel function **OPTO OFF**).

17. Opening the projector

The projector is designed to be able to be completely opened up for inspection by removing the housing as described below:

Attention

Remove the unit from mains power prior to removing the housing.

- 1) Use a flat head screwdriver to remove the screws which affix the front and rear housings.



- 2) Lift off the covers to gain access to the internals.



18. Interchanging gobos

The **iSPOT 575 MB** utilises a mechanical fastening systems which allows gobos to be interchanged without the need for any tools such as spanners or screwdrivers.

Gobos should be constructed from heat-resistant glass or metal.

A large range of gobos are available from your Coemar service centre.

Replacing gobos

Gobo dimensions:

gobo wheel 1 (closest to the lamp):

external \varnothing = 32.9 mm

image \varnothing = 26 mm

width = from 0.2 to 3.5 mm

gobo wheel 2:

external \varnothing = 32,9 mm

image \varnothing (defined border) = 28 mm

image \varnothing (undefined border) = 30 mm

width = from 0.2 to 3.5 mm

To change gobos, proceed as per the following instructions. Note that this procedure should always be undertaken with the unit switched off.

1- Open up the projector, as previously described in the section entitled: Opening up the projector.

2- Unscrew the thumbscrew, as shown in the picture below, and move the metal cover to obtain better access to the gobo wheel.



3) Remove the retaining spring from the gobo and then carefully remove any gobos.

Note that the retaining springs on the two gobo wheels are different, with bent ends on gobo wheel 2 (the one furthest from the lamp) and straight on the first. Replace the springs as they were originally when the gobo is replaced.



4) Proceed as described above to replace any other gobos.

19. Altering the operating voltage (Reserved for technical staff)

If the operating voltage set by **coemar** does not correspond to that is use in your country of operation, or if the projectors are destined for use in another country, a new operating voltage selection may be made as described below. Incorrect frequency and voltage selection will detrimentally affect the operation of the projector and immediately void the warranty.

19.1. Selecting an operating voltage on the transformer.

1) Using a Phillips-head screwdriver, loosen the screws on the base cover as shown in the diagram below, thus remove the cover to gain access to the internals of the base of the **iSPOT 575 MB**.

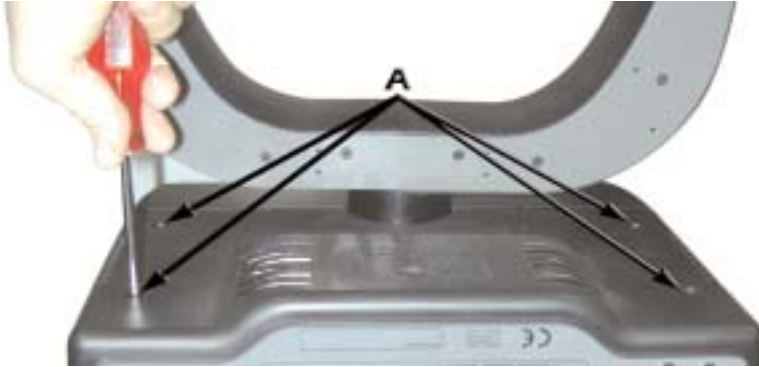

2) Locate the transformer in the base.

3) Select a voltage from between 100, 115, 208, 230 and 240V by disconnecting cable n° 5 and moving it to the required voltage. To ensure the correct voltage is selected, refer to the sticker on the transformer.

Cable number 3 should, under no circumstances, be moved from its current position.

4) If the selected voltage is 115V, replace the 8 Amp T fuse, suitable for 208/230/240 V operation, with one rated at 15 Amps T (or vice-versa). The fuse is located in the fuseholder in the base of the projector. Replacement fuses are provided in an envelope in the original packaging of the fixture alongside this instruction manual.

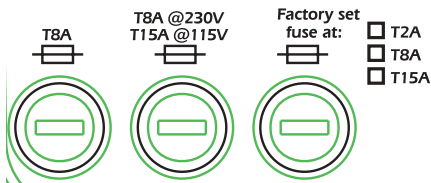

5) Make a note on the outside of the base of the **iSPOT 575 MB** of the voltage which you have selected.

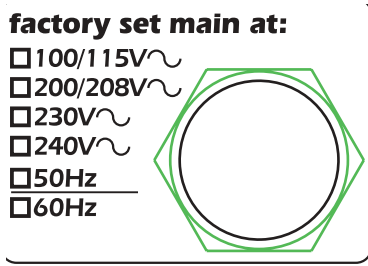

6) Replace the base cover and re-affix the screws which were previously removed.

20. Thermal protection

A thermal sensor in the body of the **iSPOT 575 MB** protects the unit against overheating. The thermal sensor removes power from the lamp should the ambient temperature exceed the set maximum or if there is a lack of air flow or there is a fan malfunction

21. Lamp circuit protection

Two timers operate simultaneously within the projector to protect the lamp ignitor and power supply against prolonged operation in non-ideal conditions.

A protection device, inside the electronic ballast, impedes attempts to power up the lamp for more than 3 seconds if the lamp has failed to ignite. The device will automatically attempt to restart the lamp for a further 3 seconds in every minute.

A software timer reattempts lamp ignition for a period of 20 seconds in every minute for up to 8 minutes; then it preserves the lamp circuit by not allowing high voltage to the lamp (assuming the lamp to have passed its useful life).

The display will show **LAER** (lamp circuit error) each time an unsuccessful attempt is made to turn on the lamp

NOTE: it is important to remove power from the fixture if the lamp has reached the end of its life and to replace the lamp.

22. Maintenance

Whilst every possible precaution has been taken to ensure the trouble-free operation of your **iSPOT 575 MB**, the following periodic maintenance is highly recommended. All maintenance should be effected with the power to the unit switched off.

Attention

Disconnect mains power prior to removing the projector housing.

To gain access to the internals of the unit, refer to section **17. Opening up the projector.**

periodic cleaning lenses and reflectors

Even a fine layer of dust can reduce the luminous output substantially. Regularly clean all lenses and the reflector using a soft cotton cloth, dampened with a specialist lens cleaning solution.

fans and air passages

The fans and air passages must be cleaned approximately every 6 weeks; the period for this periodic cleaning will depend, of course, upon the conditions in which the projector is operating. Suitable instruments for performing this type of maintenance are a brush and a common vacuum cleaner or an air compressor.

periodic maintenance lamp

The lamp should be replaced if there is any observable damage or deformation due to heat. This will avoid the danger of the lamp exploding.

mechanicals

Periodically check all mechanical devices for wear and tear; gears, guides, belts, etc., replacing them if necessary. Periodically check the lubrication of all components, particularly the parts subject to high temperatures. If necessary, lubricate with suitable lubricant, available from your coemar distributor.

electrical components

Check all electrical components for correct earthing and proper attachment of all connectors, refastening if necessary.

fuse replacement

Locate the fuse, which protects the lamp and electronics, in the base of the **iSPOT 575 MB**. Using a multimeter, test the condition of the fuse, replacing it with one of equivalent type if necessary.

23. Electronic motor alignment

Attention!
This section is reserved only for technical and specialist personnel.

The display panel of the **iSPOT 575 MB** allows for the electronic alignment of the projector's motors in the optical system. This procedure is performed by coemar at the factory. It may be useful to perform this procedure in the case of internal components being replaced.

Altering the factory settings may radically alter the functioning of the projector. Carefully read all of the following prior to attempting any changes.

electronic calibration

Attention!
Electronic calibration is only possible if the projector is receiving **DMX 512 signal**.

- 1) Press the menu button.
- 2) Press the + or - button until the display shows **RESE** (for reset).
- 3) Press the enter and menu buttons simultaneously and hold for at least 30". The motors of the unit will perform a reset and the display will show **---** for some few seconds, indicating that you have entered the electronic calibration mode:



Note: By pressing the + and - buttons simultaneously, the value returns to 128 (default).

24. Error messages

MBER:	COMMUNICATION Error This message indicates that the motherboard within the unit is not communicating properly with the control source. Check the connectors located on both boards.
OPER:	PAN ENCODER Error This message indicates that there is a problem with the PAN encoders. Check the sensors on the encoder wheel located near the pan movement motor, as well as the relevant cabling.
OTER:	TILT ENCODER Error This message indicates that there is a problem with the TILT encoder locate on the fixture yoke. Check the sensors on the encoder wheel located near the pan movement motor, as well as the relevant cabling.
SNER:	COMMUNICATION Error This message indicates that the motherboard within the unit is not communicating properly with the control source. Check the connectors located on both boards.
EPER:	EEPROM Error The EEPROM is either defective or absent; refer to your coemar service centre for a replacement component.
OTER:	DATA Error The initial parameter settings are incorrect or corrupt; the projector has reloaded its factory default settings. Turn the projector off and on again. Should the error reoccur, refer the unit to your authorised coemar service centre to have the EEPROM check and possibly replaced.
ADER:	DMX addressing Error The projector is not receiving all DMX channels needed to operate correctly. Check the DMX address indicated on the display and the channel numbers being outputted from the controller. Note that not all controllers will output all 512 channels.
STER:	Control Circuit Error relating to position sensors for 5 motors. Sensor not reading the magnet. Check for the presence of power to the PCB and the condition of the connectors and cabling between the PCB and the sensors. Additionally, check motors and/or cogs for any impediments as well as the proper position of the cabling connectors.
SZER:	Control Circuit Error relating to position sensors for 4 motors (located in the yoke at right when viewed from the rear of the unit). Sensor not reading the magnet. Check for the presence of power to the PCB and the condition of the connectors and cabling between the PCB and the sensors. Additionally, check motors and/or cogs for any impediments as well as the proper position of the cabling connectors.
SZER:	Control Circuit Error relating to position sensors for 4 motors (located in the yoke at left when viewed from the rear of the unit). Sensor not reading the magnet. Check for the presence of power to the PCB and the condition of the connectors and cabling between the PCB and the sensors. Additionally, check motors and/or cogs for any impediments as well as the proper position of the cabling connectors.
CIER:	Position Error in colour wheel number 1 (closest to lamp). Sensor not reading the magnet. Check for correct functioning of the motor and the magnetic sensor and the correct positioning with respect to the sensor and encoder wheel.
CZER:	Position Error in colour wheel number 2. Sensor not reading the magnet. Check for correct functioning of the motor and the magnetic sensor and the correct positioning with respect to the sensor and encoder wheel.
GIER:	Position Error in gobo wheel number 1 (closest to lamp). Sensor not reading the magnet. Check for correct functioning of the motor and the magnetic sensor and the correct positioning with respect to the sensor and encoder wheel..
GZER:	Position Error in gobo wheel number 2. Sensor not reading the magnet. Check for correct functioning of the motor and the magnetic sensor and the correct positioning with respect to the sensor and encoder wheel..
RIER:	Position Error in gobo indexing on wheel 1. (closest to lamp). Sensor not reading the magnet. Check for correct functioning of the motor and the magnetic sensor and the correct positioning with respect to the sensor and encoder wheel..
RZER:	Position Error in gobo indexing on wheel 2. Sensor not reading the magnet. Check for correct functioning of the motor and the magnetic sensor and the correct positioning with

respect to the sensor and encoder wheel..

LSER:

Position Error in the lens on the step zoom wheel. Sensor not reading the magnet.
Check for correct functioning of the motor and the magnetic sensor and the correct positioning with respect to the sensor and encoder wheel..

FCER:

Position Error in the focus lens. Sensor not reading the magnet.
Check for correct functioning of the motor and the magnetic sensor and the correct positioning with respect to the sensor and encoder wheel..

PRER:

Position Error in the prismatic lens. Sensor not reading the magnet.
Check for correct functioning of the motor and the magnetic sensor and the correct positioning with respect to the sensor and encoder wheel..

ER20 ÷ ER99:

SYSTEM Error
Turn the unit off and on again. If the error persists, contact your authorised coemar service centre.

25. Spare parts

All the components of the iSPOT 575 MB are available as replacement spares from your authorised coemar sales agent. Accurate description of the fixture, model number, and type will assist us in providing for your requirements in an efficient and effective manner.

26. Troubleshooting

Question	Possibile cause	Possible solution
One projector is completely immobile	No power The power switch is off The fuse may be blown	Check the power cable is correctly plugged in (see section 7 - pag 9). Set the power switch to ON. Turn off the projector and replace the fuse.
The projector resets correctly but does not respond, or responds incorrectly, to DMX signal.	Data connector is incorrectly plugged in. Incorrect DMX address The cannon plug may be incorrectly wired.	Check the connection cables for correct fit, wear or damage and replace cables if necessary. Check the fixtures DMX address. Repair or replace signal cables
No light output and the display shows "LAER".	The lamp may have reached the end of its operating life There is no lamp installed. The fuse which protects the lamp circuit may be blown.	Disconnect mains power from the unit and check the lamp. Check the lamp life meter for lamp operating hours. (for further information, check section 11.2 - pag.15) Disconnect mains power and install a lamp. Replace the fuse with one of identical value. If the fuse should blow once again, seek assistance from your Coemar service centre prior to replacing the fuse once more.
The lamp switches off in an intermittent manner.	The fixture is too hot.	Allow the fixture to cool. Check the fan inlet for any obstructions. Ensure that the ambient temperature is below 35 °C.



coemar spa

via Inghilterra
46042 Castelgoffredo (Mantova) Italy
Tel. 0376/77521
Fax 0376/780657

Coemar si riserva il diritto di apportare modifiche senza preavviso.
Coemar reserves the right to effect modifications without notification

manuale istruzioni
instruction manual

iSPOT 575 MB
1[^] edizione Giugno 2004
1st edition june 2004