



CS3

CONFERENCE SYSTEM

USER INSTRUCTIONS.....p.02

Please read before using the equipment!

用户操作说明.....p.16

使用本设备前请仔细阅读本说明书!

AKG[®]
by HARMAN

Table of Contents

Symbols Used	3
Important Safety Information.....	4
1 CS3 System	5
General.....	5
System Examples	6
2 CS3 Base Unit.....	7
Description.....	7
Features.....	7
Connectors and Controls	7
Specification.....	9
3 CS3 Chairman Unit.....	10
Description.....	10
Features.....	10
Connectors and Controls	10
Specification.....	11
4 CS3 Delegate Unit.....	12
Description.....	12
Features.....	12
Connectors and Controls	12
Specification.....	13
5 Working with CS3 System.....	14
Using the ID Switch to Set ID for Each Microphone Unit.....	14
Setting Maximum Number of Active Microphones	14
Requesting to Speak	15
Approving Speaking Request.....	15
Using Priority Function	15

Symbols Used

The lightning flash with arrowpoint in an equilateral triangle means that there are dangerous voltages present within the equipment.



The exclamation point in an equilateral triangle on the equipment indicates that it is necessary for the user to refer to the User Manual.

In the User Manual, this symbol marks instructions that the user must follow to ensure safe operation of the equipment.



The “” symbol marks important notes, hints, or explanations that make it easier to use the equipment.



When the product reaches the end of its life, separate the housing, electronics and cables and dispose of all components in accordance with local waste disposal regulations.



The packaging can be recycled. Dispose of the packaging in a suitable collection system.



Disclosure table for poisonous and harmful substances or elements of the name and content in Product:

China-RoHS Declaration

PARTS	HAZARDOUS SUBSTANCE					
	Pb	Hg	Cd	Cr ⁶⁺	PBB	PBDE
METAL PARTS	X	O	O	O	O	O
CABLES	X	O	O	O	O	O



“O”: Indicates that the concentration of the hazardous substance in homogeneous materials in the parts is below the relevant threshold of the SJ/T11363-2006 standard.

“X”: Indicates that the concentration of the hazardous substance of at least one of all homogeneous materials in the parts is above the relevant threshold of the SJ/T11363-2006 standard.

Important Safety Information



CAUTION
RISK OF ELECTRIC SHOCK
DO NOT OPEN



SAFETY

1. Read and keep these instructions.
2. Heed and follow all warnings.
3. Do not use this apparatus near water.
4. Clean only with a dry cloth.
5. Do not block any ventilation openings. Install in accordance with the manufacturer's instructions.
6. Do not install near any heat sources such as radiators, heat registers, stoves, or other apparatus (including amplifiers) that produce heat.
7. Do not defeat the safety purpose of the polarized or grounding-type plug. A polarized plug has two blades with one wider than the other. A grounding-type plug has two blades and a third grounding prong. The wide blade or the third prong is provided for your safety. If the provided plug does not fit into your outlet, consult an electrician for replacement of the obsolete outlet.
8. Protect the power cord from being walked on or pinched, particularly at plugs, convenience receptacles, and the point where they exit from the apparatus.
9. Only use attachments/accessories specified by the manufacturer.
10. Use only with a cart, stand, tripod, bracket, or table specified by the manufacturer, or sold with the apparatus. When a cart is used, use caution when moving the cart/apparatus combination to avoid injury from tip-over.
11. Unplug this apparatus during lightning storms or when unused for long periods of time.
12. Refer all servicing to qualified service personnel. Servicing is required when the apparatus has been damaged in any way, such as power-supply cord or plug is damaged, liquid has been spilled or objects have fallen into the apparatus, the apparatus has been exposed to rain or moisture, does not operate normally, or has been dropped.
13. Use the mains plug to disconnect the apparatus from the mains.
14. **WARNING: TO REDUCE THE RISK OF FIRE OR ELECTRIC SHOCK, DO NOT EXPOSE THIS APPARATUS TO RAIN OR MOISTURE.**
15. **DO NOT EXPOSE THIS EQUIPMENT TO DRIPPING OR SPLASHING AND ENSURE THAT NO OBJECTS FILLED WITH LIQUIDS, SUCH AS VASES, ARE PLACED ON THE EQUIPMENT.**
16. **THE MAINS PLUG OF THE POWER SUPPLY CORD SHALL REMAIN READILY OPERABLE.**



WARNING

TO PREVENT ELECTRIC SHOCK DO NOT REMOVE TOP OR BOTTOM COVERS. NO USER SERVICEABLE PARTS INSIDE. REFER SERVICING TO QUALIFIED SERVICE PERSONNEL.



WARNING

TO COMPLETELY DISCONNECT THIS EQUIPMENT FROM THE AC MAINS, DISCONNECT THE POWER SUPPLY CORD PLUG FROM THE AC RECEPTACLE. THE MAINS PLUG OF THE POWER SUPPLY CORD SHALL REMAIN READILY OPERABLE.



WARNING

TO REDUCE THE RISK OF ELECTRIC SHOCK, GROUNDING OF THE CENTER PIN OF THE PLUG MUST BE MAINTAINED.



WARNING

REPLACE FUSE WITH SAME TYPE FUSE AND RATING.

Important Safety Information

Safety

Information technology equipment - Safety -- Part 1: General requirements

IEC 60950-1:2005 Edition 2

Information technology equipment - Safety -- Part 1: General requirements

CAN/CSA-C22.2 No 60950-1-07 Incl.
AM1 (2011)

Information technology equipment - Safety -- Part 1: General requirements

ANSI/UL Std No 60950-1, 2nd Ed. Incl.
AM1 (2011)

This device complies with part 15 of the FCC rules. Operation is subject to the following two conditions: (1) This device may not cause harmful interference, and (2) this device must accept any interference received, including interference that may cause undesired operation.

FCC COMPLIANCE NOTICE

This product conforms to the standards listed in the related Declaration of Conformity. To order a free copy of the declaration of Conformity for this product, visit <http://www.akg.com> or contact sales@akg.com.

COMPLIANCE TO EUROPEAN DIRECTIVES

1 CS3 System

The CS3 System is a modular and flexible conference system for small and medium size applications. The CS3 components can be easily set up, wired, and expanded. A CS3 system can support up to 128 microphone units (Delegate Units and Chairman Units).

General

- Make sure the grounding cable should be connected to the earth before connecting the input and output of this system, avoiding any risk of electric shock.
- To avoid data loss or corruption, malfunctioning, or damage to the system, never make any changes to the wiring or operate any control on any system component, or disconnect the system from power while a software update is in progress.
- To avoid damage to any system component, do not lay, connect, or disconnect any cables while power to the system is on. Always disconnect the entire system from power before making any changes to the wiring.
- Note that the CS3 BU will not function with no microphone units connected to it. Therefore, make sure to always connect at least one microphone unit to the base unit to set up a functional CS3 system.
- Custom wiring should only be performed by qualified personnel.



1 CS3 System

System Examples

Example 1: Simple discussion system

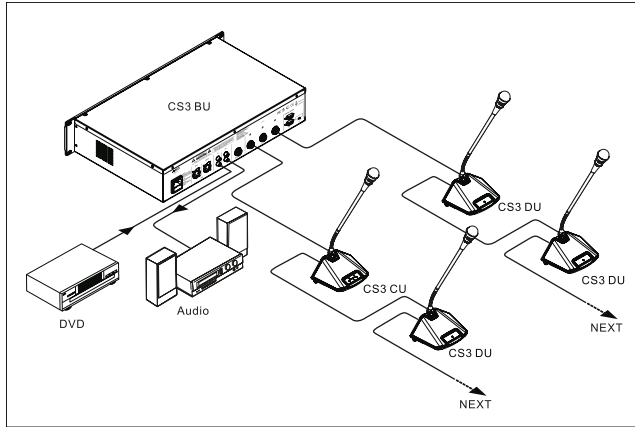

Fig.1: Example 1.

Refer to Fig.1.

Example 1 above shows the wiring diagram for a simple discussion system. A system of this kind may be comprised of a CS3 BU, a CS3 CU and several sets of CS3 DU.

Example 2: Larger discussion system with computer control and video tracing

Fig.2: Example 2.

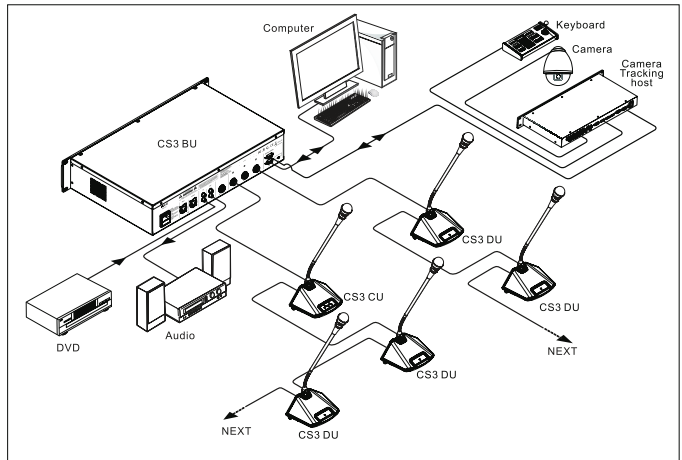

Refer to Fig.2.

Example 2 above shows a larger discussion system with more than six microphone units and computer control. The computer controlling system is connected to RS-232 port on CS3 BU.



For the connection of CS3 System with external devices such as DVD player, speaker system, and camera, please use the specified interface as mentioned in "Rear Panel" on page 8.

Description

CS3 BU (Base Unit) is a Base Unit required for any CS3 system configuration. It synchronizes all system components and generates the floor audio channel. The CS3 BU can be connected to external audio sources, an external amplifier, and an audio recording device.

CS3 BU provides the following basic control functions:

- NOM limitation: The number of microphones which are activated simultaneously, selectable as 1, 2, 4 or 6.
- Four selectable conference modes: Override, Normal, Free and Request.
- Adjustable bass, treble, and master volume.

For more control functions you can use through the CS3 ConferControl software, please refer to the *CS3 ConferControl Software Manual* that comes with your software.

- Capable of supporting 60 microphone units.

Features

The number of connecting microphones must be adjusted in accordance with the system load and connecting distance in practical applications.



- Specific 8-pin DIN plug
- Bus connection mode
- 2-channel mono audio inputs
- 2-channel mono original audio outputs
- Adjustable maximum number of active microphones (applied to delegate units only), with 1, 2, 4, and 6 options. No limitation to CS3 CU
- Four conference modes: Override, Normal, Free and Request
- Adjustable bass, treble, and master volume
- Video tracing function through the "central control" output
- Remote telephone conference along with telephone coupler
- Suitable for 19-inch standard rack installation

When using an equipment rack, DO NOT block front or rear air vents. Do allow at least 1.0cm clearance above the equipment and at least 1.0cm clearance of both sides of the equipment for proper heat dissipation.



Connectors and Controls

Front Panel

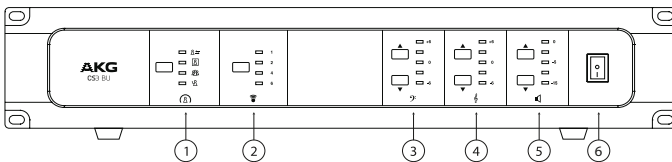



Fig.3: CS3 BU Front Panel.

Refer to fig.3.



1. Conference Mode:





Override Mode : In Override mode, if the number of active microphones is at maximum, the earliest activated microphone will be muted when the additional microphone is activated by pressing the Speak Button.

2 CS3 Base Unit

Normal Mode  In normal mode, the CS3 DU microphones which are over the active number will automatically queue up.



Free Mode  This mode allows up to 20 CS3 DU microphones to be activated simultaneously. This is not limited by the maximum number of active microphones. When there are 20 active DU microphones, pressing the Speak Button of additional CS3 DU will not activate the microphone.

Request Mode  In request mode, chairman can press Approve Button  of CS3 CU to approve the speaking request from CS3 DU in turn. The maximum number of request is 6 and not limited by the NOM. The request over 6 will be invalid. Please refer to “Approving Speaking Request” on page 15 for the operating instructions.

2. **NOM**  : The number of microphones of CS3 DU which is allowed to be activated simultaneously, with 1, 2, 4 and 6 options.
3. **Bass**  : Adjusts the output bass volume with -6dB, -2dB, 0dB, +2dB, and +6dB options.
4. **Treble**  : Adjusts the output treble volume with -6dB, -2dB, 0dB, +2dB, and +6dB options.
5. **Master Volume**  : Adjusts the output master volume with -15dB, -10dB, -5dB, -3dB, and 0dB options.
6. **Power Switch**: Switches ON or OFF of both CS3 BU and the CS3 system.



NOTE

Pressing the button  every time in the conference mode  or NOM  section will switch between options. The LED besides the corresponding option will light on which indicates the option is selected.

Rear Panel

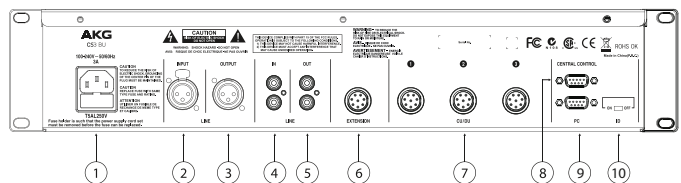
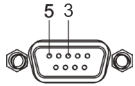

Fig. 4: Rear Panel.

Refer to fig.4.

1. **Power Input**: Supports AC100V-240V 50Hz/60Hz.
2. **XLR Input**: Balanced XLR input, such as background music or remote telephone conference output.
3. **XLR Output**: Balanced XLR connector connects to loudspeaker system or recording devices, including conference audio (CU/DU input) and audio input (LINE IN).
4. **LINE IN**: 2-channel audio input, such as CD Player or remote telephone conference output.
5. **LINE OUT**: 2-channel audio output, connects to loudspeaker system or recording devices, including conference audio (CU/DU input) and audio input (LINE IN).

- 6. **EXTENSION:** Provides connection to extension units.
- 7. **CU/DU:** Provides connection to CS3 CU or CS3 DU.
- 8. **CENTRAL CONTROL:** Provides connection to external video tracing system.



Control System	Pin	Signal	Description
	3	TXD	Send data
	5	GND	Signal Grounding

- 9. **PC Connector:** Provides connection to computer, allowing conference management by the CS3 ConferControl software.

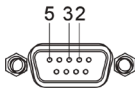

Control System	Pin	Signal	Description
	2	TXD	Send data
	3	RXD	Receive data
5	GND	Signal Grounding	



- 10. **ID Switch:** Enables to set ID numbers for microphone units. For more detailed operating instructions, please refer to "Using the ID Switch to Set ID for Each Microphone Unit" on page 14.

CS3 BU (Base Unit)	
Power Supply	SMPS 100-240V (50Hz / 60Hz) 3A
Static Consumption	13W
Nominal Power Consumption	320W
Output Power	≤90W / 24V each way
Mode	Balanced / Unbalanced
Frequency Response	50Hz ~ 20kHz
S/N	>80dB
Harmonic Distortion	<0.5%
Harmonic Distortion at Overload	<1%
Crosstalk Attenuation (1kHz)	>50dB
Dimension	482L x 281W x 88.4H (mm)
Weight	About 5.2kg
Operating Temperature	0°C to 40 °C at 95% relative humidity (non-condensing)

Specification

3 CS3 Chairman Unit

Description

CS3 CU (Chairman Unit) is a basic microphone unit for CS3 system. It contains a Speak Button , a Priority Button , an Approve Button , a built-in loudspeaker, and two headphone jacks as well as a connector to other microphone units.

CS3 CU can approve the speaking request from CS3 DU. The maximum number of active microphone, conference modes and connection position of CS3 CU are not limited. And it also has the privilege of muting all other delegate units in CS3 system as well.

Features

- Capable of driving 30 microphone units for a single channel. Cannot drive to more than 60 microphone units for three channels totally.



CAUTION

The number of connecting microphones must be adjusted in accordance with the system load and connecting distance in practical applications.

- Adopts specific 8-pin high-quality DIN connector to ensure the secure connection and stable system operation
- Packaged with 2-meter connecting cable
- With 2W built-in speaker
- With 2 ports of 3.5mm headphone jacks and a master volume adjustment knob
- Powered by CS3 BU
- Mutes built-in speaker automatically when microphone is activated for speaking to avoid feedback
- Connects in bus connection mode which is simple and convenient
- Provides approve function to activate CS3 DU microphone after sending speaking request
- No limitation on the connection number of microphone units
- Provides priority function for whole control of the discussion
- No limitation on the connection position of CS3 CU

Connectors and Controls

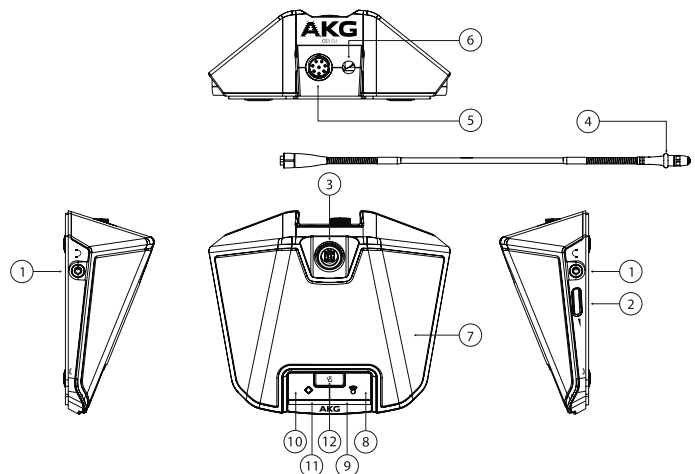

Fig.5: CS3 CU Controls.

Refer to fig.5.

1. **3.5mm Headphone Jack:** Provides connection to headphone for listening to the conference speech and background music in real-time.

2. **Volume Adjustment Knob:** Adjusts the master volume of speaker and headphone
3. **Microphone Connector:** Provides connection to microphone.
4. **Microphone Indicator:** It lights red when microphone is activated. It turns off when deactivated.
5. **8-Pin DIN Connector:** Provides the connection of microphones in bus connection mode (series connection).
6. **2-meter Cable with Connector:** Connects CS3 CU to base unit or previous microphone unit within bus connection.
7. **Built-in Speaker:** Play back mixing-audio like conference speech or background music in real-time.
8. **Speak Button**  : Press to activate the microphone and press again to deactivate.
9. **Speak Indicator:** It lights blue when microphone unit is connected to the power supply. It lights red when microphone is activated by user.
10. **Priority Button**  : Briefly press to mute the active microphone of Delegate Unit (the microphone indicator of these delegate unit flashes) and activate the microphone of Chairman Unit. Briefly press again to reactivate the delegate units which are muted. Press and hold for 3 seconds to cancel all operations of the delegate units (including speaking, requesting and waiting) and activate the microphone of Chairman Unit.
11. **Priority Indicator:** It lights blue when microphone unit is connected to the power supply. It lights red when priority function is activated by user.
12. **Approve Button & Approve Indicator** : In request mode, the approve indicator blinks when there is an incoming speaking request from CS3 DU. Press Approve Button  to approve the speaking request. As a result, the microphone of the requesting CS3 DU will be activated. Please refer to "Approving Speaking Request" on page 15 for more detailed operating instructions.

Specification

CS3 CU (Chairman Unit)	
Power Supply	DC24V Supplied by the Base Unit
Power Consumption	3W
Loudspeaker Power	2W
SNR	>80dB
Frequency Response	50Hz ~ 20kHz
Intercommunication	DIN 8-pole
Headphone Output	9dBu, 8-32ohm, 3.5mm
Crosstalk Attenuation	>80dB
Harmonic Distortion	<0.1%
Dimension	170L x 143W x 63H (mm)
Weight	About 1kg
Operating Temperature	0°C to 40 °C at 95% relative humidity (non-condensing)

4 CS3 Delegate Unit

Description

CS3 DU (Delegate Unit) is a basic microphone units for CS3 conference system. It contains a Speak Button , a built-in loudspeaker, and two headphone jacks as well as a connector to other microphone unit. User can listen to conference speech through built-in speaker or headphone.

Features

- Capable of driving 30 microphone units for a single channel. Cannot drive to more than 60 microphone units for three channels totally.



CAUTION

The number of connecting microphones must be adjusted in accordance with the system load and connecting distance in practical applications.

- Adopts specific 8-pin DIN connector to ensure the secure connection and stable system operation.
- Packaged with 2-meter connecting cable.
- With 2W built-in speaker.
- With 2 ports of 3.5mm headphone jacks and a master volume adjustment knob.
- Powered by CS3 BU.
- Mutes built-in speaker automatically when microphone is activated for speaking to avoid whistle.
- Connects in simple and convenient bus connection mode.

Connectors and Controls

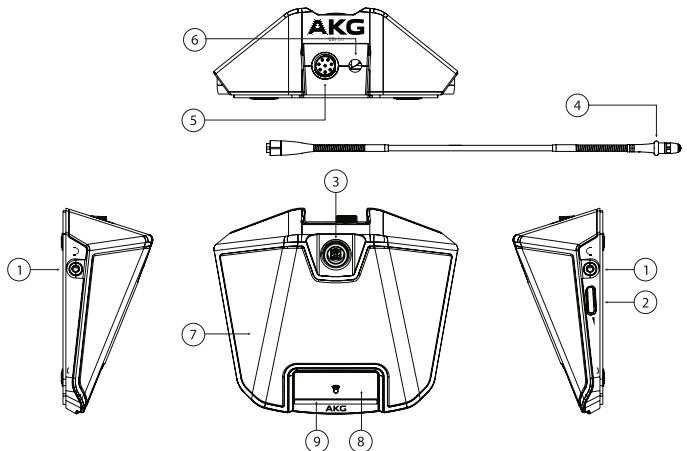

Fig.6: CS3 DU Controls.

Refer to fig.6.

1. **3.5mm Headphone Jack:** Connects headphone to listen to the conference speech and background music in real-time.
2. **Volume Adjustment Knob:** Adjusts the master volume of speaker and headphone.
3. **Microphone Connector:** Provides connections to microphone.
4. **Microphone indicator:** Lights red when microphone is activated, turns off when deactivated, and blinks when sending speaking request.

5. **8-Pin DIN Connector:** Provides the connection of microphones in bus connection mode (series connection).
6. **2-meter Cable with Connector:** Connects CS3 DU to base unit or previous microphone unit within bus connection.
7. **Built-in Speaker:** Play back mixing-audio like conference speech or background music in real-time.
8. **Speak Button**  : Press to activate the microphone and press again to deactivate.
9. **Speak Indicator:** It lights blue when microphone unit is connected to the power supply. It blinks when microphone unit is sending a speaking request. It lights red when microphone is activated by user.

Specification

CS3 DU (Delegate Unit)	
Power Supply	DC24V Supplied by the Base Unit
Power Consumption	3W
Loudspeaker Power	2W
SNR	>80dB
Frequency Response	50Hz ~ 20kHz
Intercommunication	DIN 8-pole
Headphone Output	9dBu, 8-32ohm, 3.5mm
Crosstalk Attenuation	>80dB
Harmonic Distortion	<0.1%
Dimension	170L x 143W x 63H (mm)
Weight	About 1kg
Operating Temperature	0°C to 40 °C at 95% relative humidity (non-condensing)

5 Working with CS3 System



Please correctly connect units to CS3 BU and set their ID before operating on CS3 system.

Using the ID Switch to Set ID for Each Microphone Unit

Unique ID must be set for each microphone unit in CS3 system so that CS3 BU can identify each of them. Follow the steps below to set ID:

1. Power on CS3 BU after correctly connecting with units.
2. Set ID switch on the rear panel of CS3 BU to "ON" position.
3. Press Speak Button  of corresponding unit. ID is set when speak indicator lights red.
4. Repeat Step 3 to set ID for the rest of the units.
5. Set ID switch to "OFF" position after ID of all microphone units are set, and then speak indicators of all set microphone units light blue. The system is ready to use.





Setting Maximum Number of Active Microphones

The way of setting maximum number of microphones varies upon the conference modes enabled. This setting is invalid in free mode. Please read "Connectors and Controls" on page 7 for more details.



It is suggested to estimate the number of microphones which will be activated simultaneously before using CS3 system. Set the maximum number of active microphones and then select the desired conference mode.

For example, to set the maximum number of active microphones which is estimated to be 2 in Request Mode , follow the steps below:

1. In CS3 system, press the button  in NOM  section on the front panel of CS3 BU several times to select "2". The LED besides "2" will light on.
2. Press the button  in conference mode  section on the front panel of CS3 BU several times until the LED besides  lights on to select the request mode.
3. The NOM is set as 2 for Request mode.

5 Working with CS3 System

Once the maximum number of active microphones is set in request mode, the additional CS3 DU can send the speaking request to CS3 CU.

Requesting to Speak

To send a speaking request, follow the steps below:

1. Press Speak Button  and the microphone indicator blinks.
2. Once the speaking request is approved by CS3 CU, the microphone indicator and speak indicator lights on and microphone is activated at the same time. If CS3 CU does not approved in 15 seconds, both indicators turn off and the request is cancelled automatically.

If there are more than one CS3 DU requesting to speak simultaneously, they will queue up automatically. The maximum number of request is 6. The additional request will be invalid and its microphone indicator will not blink by pressing the Speak Button .





NOTE

Once the maximum number of active microphones is set in request mode, the CS3 CU can approve the speaking request from CS3 DU.

Approving Speaking Request

To approve a speaking request, follow the steps below:

1. The approve indicator of CS3 CU blinks when a speaking request is received.
2. Press the Approve Button  to approve the request which activate the CS3 DU microphone.

If there are more than one CS3 DU requesting to speak simultaneously, they will queue up automatically. The maximum number of request is 6. The additional request will be invalid and pressing the Speak Button  of the additional microphone units will not make the approve indicator of CS3 CU blink.





NOTE

The CS3 CU approves the speaking request one by one by pressing the Approve Button  and the approve indicator will turn off after all requests are approved.



If needed, CS3 CU can use priority function.

Using Priority Function

To mute the active microphone of delegate units:

1. Press the Priority Button  of CS3 CU (the microphone and priority indicators light red). The active microphone of delegate units will be muted (their microphone indicators flash) and the microphone of CS3 CU is activated.
2. Press the Priority Button  of CS3 CU again. The delegate units which are muted will be reactivated and the priority function of CS3 CU will be turned off (the priority indicator lights blue).

To cancel all operations of the delegate units:

1. Press and hold the Priority Button  of CS3 CU for about 3 seconds (the microphone and priority indicators light red). The operation of all delegate units (including speaking, requesting and waiting) will be cancelled and the microphone indicators of all delegate units will turn off. The microphone of CS3 CU is activated.
2. Press the Speak Button  of CS3 CU to turn off its microphone (CS3 CU speak indicator lights blue). Press the Priority Button  of CS3 CU, the priority function of CS3 CU will be turned off (the priority indicator lights blue).

目录

符号说明	17
重要安全信息	18
1 CS3会议系统	19
概述	19
系统连接示例	20
2 CS3 BU主机	21
简介	21
主要特点	21
接口和控制	21
规格	23
3 CS3 CU主席话筒	24
简介	24
主要特点	24
接口和控制	24
规格	25
4 CS3 DU代表话筒	26
简介	26
主要特点	26
接口和控制	26
规格	27
5 使用CS3会议系统	28
设置话筒单元ID	28
设置最多代表话筒发言数	28
申请发言	29
批准发言	29
使用优先按键	29

说明书和设备上都使用了符号，指出可能对用户或他人造成的伤害以及财产受损的风险，以便您能够安全、正确地使用设备。指示及其含义如下。请确保在阅读说明书之前正确理解这些符号的警示。

提醒使用者设备内出现的未绝缘危险电压可能使人遭受电击。



电击提示

此为A级产品，在生活环境中，该产品可能会造成无线电干扰。在这种情况下，可能需要用户对干扰采取切实可行的措施。



警告

表示可能导致操作或设置不成功的内容及一些需要注意的相关信息。



注意

如果您需要丢弃本产品，请勿将其与一般家居废品混放。对于电子产品的废弃，请遵循当地电子电气设备废弃物指令正确处理、恢复和回收，将废弃产品统一回收到独立的回收系统。



该产品包装可循环再用。如果您要丢弃该包装，请统一回收到适当的回收系统。



产品中有毒有害物质或元素的名称及含量：

中国RoHS声明

部件名称 (PARTS)	有毒有害物质或元素 (HAZARDOUS SUBSTANCE)					
	铅 (Pb)	汞 (Hg)	镉 (Cd)	六价铬 (Cr ⁶⁺)	多溴联苯 (PBB)	多溴二苯醚 (PBDE)
金属部件 (METAL PARTS)	X	○	○	○	○	○
线材 (CABLES)	X	○	○	○	○	○



“○”：表示该有毒有害物质在该部件所有均质材料中的含量均在SJ/T11363-2006标准规定的限量要求以下。

“X”：表示该有毒有害物质至少在该部件的某一均质材料中的含量超出SJ/T11363-2006标准规定的限量要求。

重要安全信息



CAUTION
RISK OF ELECTRIC SHOCK
DO NOT OPEN



安全操作

1. 阅读本手册。
2. 保留本手册。
3. 留意所有的警告。
4. 遵守本手册中的所有操作说明。
5. 不要在近水区域使用本产品。
6. 仅用干布清洁擦拭本产品。
7. 不要阻挡任何通风口，并严格按照制造商提供的操作说明进行安装。
8. 不要靠近任何热源安装，比如散热器、电热器、火炉或者其他产生热量的设备（包括功放）。
9. 不要破坏具有安全功效的极性插头或者接地式插头。极性插头有两个插片，一个宽，一个窄。接地式插头有两个插片和一个接地针，其中宽插片或者接地针是用来保障您的安全的。如果所提供的插头不适合您的插座，请咨询联系电工更换适合的插座。
10. 保护电源线。避免电源线被踩踏或者被捻搓。特别注意保护在插头、便捷插座和电源线接出设备处的电源线。
11. 仅使用制造商指定的附件或选件。
12. 仅使用制造商指定的或者随本产品一同出售的载车、支架、三角架、托架或者工作台。在使用推车运输设备时，特别注意推车及设备，避免其翻倒造成伤害。
13. 在有雷电时或者长时间不使用本设备时，请拔掉插头。
14. 所有维修服务必须由有资格的维修人员提供。当设备受到任何形式的损坏时，比如电源线或者插头被损坏，液体或者异物掉入设备，遭受雨淋或受潮，不能正常工作，以及被摔碰等情况，都需要维修。
15. 警告：为了减小起火或者电击的风险，不要让设备遭受雨淋或者受潮。
16. 不要将设备放置在容易遭受滴漏或者喷洒的地方。例如，不要将装有液体的物品，比如花瓶等放到设备上。



电击提示

为了避免电击，请不要拆卸设备。设备内部无用户可以自行维护的部件。请向有资格的服务人员咨询。



电击提示

要完全断开此设备与交流电主线的连接，请把电源线插头从交流电插座中拔出。需要连接电源时，可再次将电源线插头插入交流电插座。



电击提示

为避免电击危险，务必使用插头的接地针脚，切勿移除。



电击提示

更换保险丝时，务必使用同类型同功率的保险丝。

安全标准

信息技术设备的安全性，第1部分：一般要求。

IEC 60950-1:2005 Edition 2

信息技术设备的安全性，第1部分：一般要求。

CAN/CSA-C22.2 No 60950-1-07
Incl. AM1 (2011)

信息技术设备的安全性，第1部分：一般要求。

ANSI/UL Std No 60950-1, 2nd
Ed. Incl. AM1 (2011)

FCC的符合性说明

此设备符合美国通信委员会规则的第15部分内容。其工作符合如下两个条件：（1）此设备可能不引起有害的干扰，（2）此设备会接受任何可接收范围的干扰，包括可能引起其非正常工作的干扰。

符合性声明

本产品符合相关符合性声明所列举的标准。如果您需要本产品相关符合性声明文件的副本，请访问 <http://www.akg.com>或联系sales@akg.com 索取。

1 CS3会议系统

CS3会议系统是一套模块化的灵活的会议系统，适用于中小型会议应用。CS3会议系统由CS3 BU主机、CS3 CU主席话筒和CS3 DU代表话筒组成。各组件极易安装，连接和扩展。使用一台主机的CS3会议系统可以连接60台话筒单元。

概述

- 本产品通过电源线的接地导线接地，为避免电击，必须将接地导线与大地相连，在对本产品的输入端或输出端进行连接之前，请务必将本产品正确接地。
- 为避免数据遗失和失误及系统故障和损坏，请勿擅自更改连接线路，使用任何系统组件对其进行操控，或在进行软件更新时断开系统电源。
- 为避免对系统组件造成任何损坏，请勿在系统通电状态下，铺设、连接或断开任何线缆。在对系统连线前，请务必确保已断开系统的电源连接。
- 如果主机无任何话筒单元连接，主机无法完成操作。请确保至少一台话筒单元连接到主机，组成一套可工作的CS3会议系统。
- 此设备的接线工作必须由专业人员或经过培训的人员进行操作。



警告

1 CS3会议系统

系统连接示例

示例1：简单的讨论系统



图7：示例1

参照图7

如上示例1为一套简单的讨论系统所采用的连线示意图。一套这样的系统可以由一台CS3主机、一台CS3主席话筒和多台CS3代表话筒组成。

示例2：可通过计算机或摄像跟踪操控的较大讨论系统

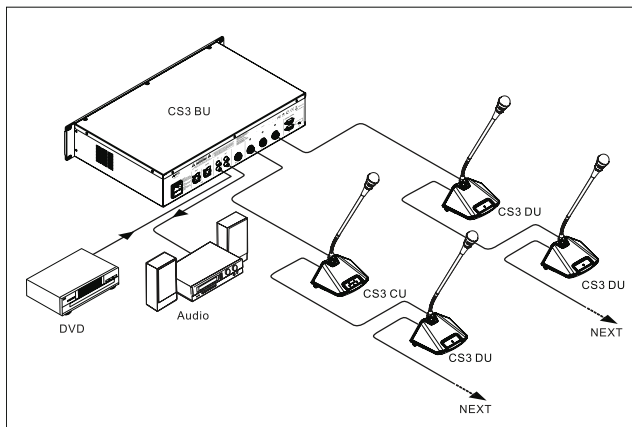
图8：示例2

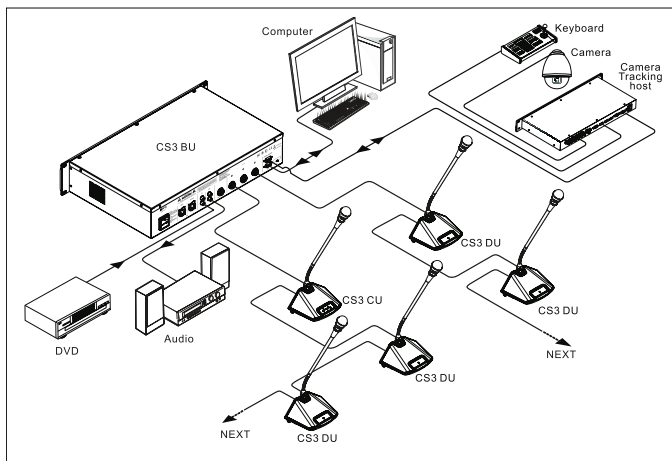

参照图8

示例2为连接超过6个话筒单元及计算机的较大讨论系统。可通过RS-232串口将主机与计算机连接，实现对会议系统的设置和控制。



注意

有关CS3会议系统与外部设备的连接，如DVD播放器、扬声器系统、摄像机，请使用本说明书中指定的接口，请见第22页的“后面板”。

CS3 BU主机是任何CS3会议系统配置必须的组件之一。主机可以同步化所有系统组件，并产生同一音频通道。您可以将CS3 BU主机与外部音源，外部功放和音频录制设备相连接。

CS3 BU主机提供如下基本控制功能：

- 最多代表话筒发言数：设定允许同时发言代表话筒的最多台数，可选1、2、4或6
- 四个可选会议模式：OVERRIDE、常规、自由和申请模式
- 可调节低音、高音和总音量

您可通过CS3 ConferControl软件设置和控制CS3会议系统，有关更多功能使用，请参阅软件说明书。软件说明书可在CS3 ConferControl操作界面帮助菜单下打开。

- 可连接60台话简单元。

主要特点

连接话筒数量需要根据实际应用中的系统负载和连接距离来调整。



警告

- 专用8芯插头连接，保证连接牢固，稳定可靠
- “手拉手”连接模式
- 两路单声道音频输入接口
- 两路单声道源音输出
- 最多代表话筒发言数功能，提供同时1台、2台、4台或6台代表话筒发言。主席话筒不受限制。
- 四种会议模式：OVERRIDE、常规、自由和申请
- 可调低音、高音、和总音量
- 自动摄像跟踪功能
- 配合电话耦合器可实现远程电话会议功能
- 适于19英寸标准机柜安装

在使用设备支架时，不要阻挡前面和后面的通风口。机器上方，以及各侧面至少保留1厘米的空间，以保证正常的散热。



警告

接口和控制

前面板





图9：CS3 BU前面板控制



参照图9

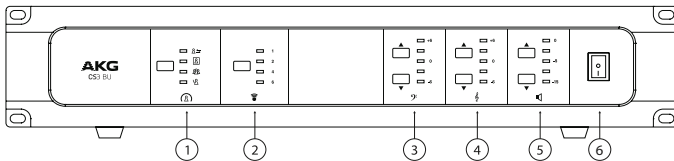



1. 会议模式：

OVERRIDE：在此模式下，当代表话筒达到最多发言数限值时，下一个（超出最多发言数的）代表话筒发言，最先发言的代表话筒将被关闭。

 **常规**: 在此模式下,代表话筒达到最多发言数限值时,另外的代表话筒发言,将逐一进入等待队列。

 **自由**: 在此模式下,允许最多20台代表话筒同时发言,而不受主机所设最多代表话筒发言数限制。达到20台后,按下另外代表话筒的发言按键,发言将无效。

 **申请**: 在此模式下,代表话筒申请发言,需要按下主席话筒同意按键  逐个批准。允许最多6台(不受主机所设最多代表话筒同时发言限制)代表话筒申请发言。超过6台的代表话筒申请发言无效。有关操作,可详见第29页的“批准发言”。

2. 最多代表话筒发言数 : 此功能可设置同时发言的代表话筒台数,可选1、2、4或6。
3. 低音 : 用于调节低音输出音量,可选-6dB、-2dB、0dB、+2dB或+6dB,指示灯表示当前低音的大小。
4. 高音 : 用于调节高音输出音量,可选-6dB、-2dB、0dB、+2dB或+6dB,指示灯表示当前高音的大小。
5. 总音量 : 用于调节总输出音量,可选-15dB、-10dB、-5dB、-3dB或0dB,指示灯表当前总音量的大小。
6. 电源开关: 用于开启CS3 BU主机及整个CS3会议系统的电源。



注意

每一次按下前面板对应的功能区域的按键 , 会在不同选项间切换, 对应选项灯会亮, 表示该选项被选中。

后面板



图10: 后面板

参照图10

1. 电源接口: 供连接AC电源, 支持AC100V-240V 50Hz/60Hz。
2. XLR输入接口: 平衡线路电信号输入接口, 输入音频, 如背景音乐或远程电话会议终端输出。
3. XLR输出接口: 平衡线路电信号输出接口, 供连接扩声系统或录音设备使用, 包含会议音频(CU/DU输入)和线路输入(LINE IN)音频。
4. LINE IN(线路输入): 两路线路音频输入, 如CD播放器和远程电话会议终端输出。
5. LINE OUT(线路输出): 两路线路音频输出, 供连接扩声系统或录音设备使用。此输出包含会议音频(CU/DU输入)和线路输入(LINE IN)音频。
6. EXTENSION(扩展接口): 供连接扩展主机使用。多台扩展主机“手拉手”串联连接。

7. CU/DU: 供与主席话筒和代表话筒连接使用。
8. CENTRAL CONTROL (中央控制): 供与外部摄像头设备连接使用, 实现自动摄像跟踪功能。

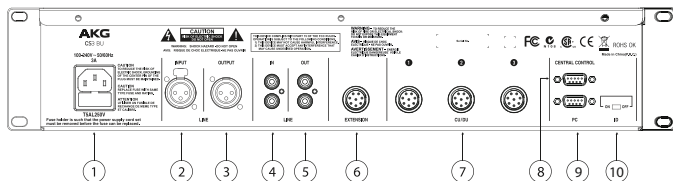
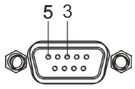

控制系统	针脚	信号	描述
	3	TXD	发送数据
	5	GND	信号地

9. PC接口: 供与计算机连接使用, 实现软件设置和控制会议。

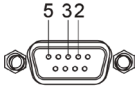

控制系统	针脚	信号	描述
	2	TXD	发送数据
	3	RXD	接收数据
5	GND	信号地	

10. ID开关: 供设置主席或代表话筒ID使用。有关ID设置, 请见第28页的“设置话筒单元ID”。

CS3 BU控制主机	
电源	SMPS 100-240V (50Hz / 60Hz) 3A
静态功耗	13W
最大功率	320W
输出功率	≤90W / 24V · 每路
音频输出方式	平衡 / 非平衡
频率响应	50Hz - 20kHz
信噪比 (S/N)	>80dB
谐波失真	<0.5%
过载波失真	<1%
串音衰减 (1k Hz)	>50dB
尺寸	482L x 281W x 88.4H (mm)
重量	约5.2kg
工作温度	0°C到40°C, 95%相对湿度 (非冷凝)

规格

3 CS3 CU主席话筒

简介

CS3 CU主席话筒是CS3会议系统的基本话筒之一。它具有一个发言按钮、一个优先按钮、一个同意按钮、一个内置扬声器和两个耳机接口，并提供与另一台话筒单元连接的接口。用户可通过内置扬声器和耳机接口听取会议内容。

CS3 CU主席话筒可批准CS3 DU代表话筒申请发言，并不受最多代表话筒发言数和会议模式影响，还可关闭代表话筒优先发言，其连接也不受位置限制。

主要特点

- 单通道最多可连接30台话筒单元。三个通道总共最多连接不超过60台话筒单元。



警告

连接话筒数量需要根据实际应用中的系统负载和连接距离来调整。

- 专用8芯插头连接接头，确保连接牢固，系统稳定可靠
- 自带2米连接线缆
- 2W内置扬声器
- 两个3.5mm耳机插口和一个音量调节旋钮
- 由CS3 BU主机供电
- 话简单元开启时本机内置扬声器自动关闭，有效防止啸叫
- 简单方便的“手拉手”式连接
- 批准代表话筒申请发言功能
- 发言话简单元台数不受限制
- 优先功能确保主席单元可全权控制代表话筒发言的发言秩序
- 连接位置不受限制

接口和控制







图11：CS3 CU接口和控制

参照图11

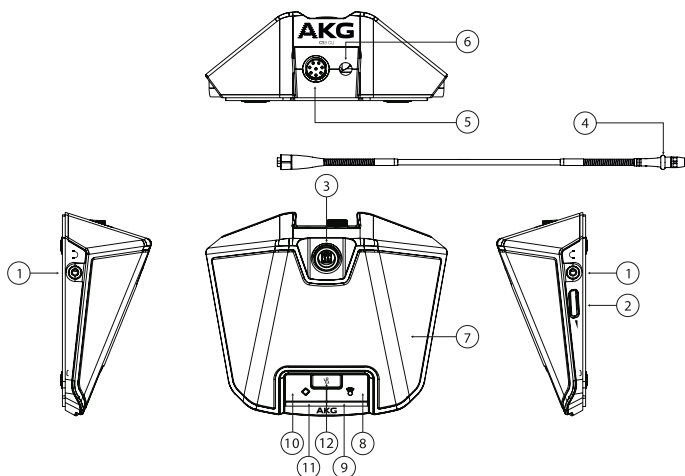
1. 3.5mm耳机接口：用于连接耳机实时听取会议内容及背景音乐。

2. 音量调节旋钮：用于调节扬声器和耳机音量大小。
3. 咪杆接口：用于连接咪杆。
4. 咪杆指示灯：打开话单元，咪杆指示灯点亮为红色；关闭话单元，咪杆指示灯熄灭。
5. 8芯公座：用于对话单元进行“手拉手”式连接，即串联。
6. 带母头的2米线缆：用于连接主机或上一台连接的话单元。
7. 内置扬声器：回放混和音频，实时听取会议内容或背景音乐。
8. 发言按键 ：按下此按键开启话筒发言功能，再次按下此键，退出发言状态。
9. 发言按键指示灯：话单元通电时，此灯点亮为蓝色，表示话筒就绪；按下发言按键后，指示灯点亮为红色，表示话筒已进入发言状态。
10. 优先按键 ：短按此按键，暂停正在发言的代表话筒发言（该代表话筒咪杆指示灯闪烁），同时开启主席话筒发言功能；再次短按此按键，恢复原发言的代表话筒发言功能。长按此按键三秒取消所有代表单元的操作（包括正在发言、申请发言、等待发言），同时开启主席话筒发言功能。
11. 优先指示灯：话单元通电时此灯点亮为蓝色。当启动优先功能时，此灯点亮为红色。
12. 同意按键及同意按键指示灯 ：在申请模式下，当有代表话筒申请发言，主席话筒同意键指示灯将闪烁，可按下主席话筒上的同意按键  批准代表话筒发言，代表话筒随即进入发言状态。有关详细操作，请见第29页的“批准发言”。

CS3 CU 主席单元	
电源	DC24V（主机供电）
功率消耗	3W
扬声器功率	2W
信噪比（S/N）	>80dB
频率响应	50Hz - 20kHz
通信接口	8芯专用接口
耳机输出	9dBu, 8-32ohm, 3.5mm
串音衰减	>80dB
谐波失真	<0.1%
尺寸	170L x 143W x 63H (mm)
重量	约1kg
工作温度	0°C到40°C, 95%相对湿度（非冷凝）

规格

4 CS3 DU代表话筒

简介

CS3 DU代表话筒是CS3会议系统的基本话筒之一。它具有一个发言按键、一个内置扬声器和两个耳机接口，并提供与另一台话单元连接的接口。用户可通过内置扬声器和耳机接口听取会议内容及音乐背景。

主要特点

- 单通道最多可连接30台话单元。三个通道总共最多连接不超过60台话单元。



警告

连接话筒数量需要根据实际应用中的系统负载和连接距离来调整。

- 专用8芯插头连接接头，确保连接牢固，系统稳定可靠
- 自带2米连接线缆
- 2W内置扬声器
- 两个3.5mm耳机插口和一个音量调节旋钮
- 由CS3 BU主机供电
- 话筒开启时本机内置扬声器自动关闭，有效防止啸叫
- 简单方便的“手拉手”式连接

接口和控制





图12：CS3 DU接口和控制
参照图12

1. 3.5mm耳机接口：用于连接耳机实时监听。
2. 音量调节旋钮：用于调节扬声器和耳机音量大小。
3. 咪杆接口：用于连接咪杆。
4. 咪杆指示灯：打开话单元，咪杆指示灯点亮为红色；关闭话单元，咪杆指示灯熄灭；申请发言时，咪杆指示灯闪烁。
5. 8芯插座：用于对话单元进行“手拉手”式连接，即串联。
6. 带母头的2米线缆：用于连接主机或上一台连接的话单元。
7. 内置扬声器：播放混和音频，实时听取会议内容或背景音乐。

8. 发言按键 ：按下此按键开启发言功能或申请发言。
9. 发言按键指示灯：话筒通电时，此灯点亮为蓝色，表示话筒就绪；按下发言按键后，咪杆指示灯闪烁，表示正在申请发言；当发言指示灯点亮为红色，表示话筒已进入发言状态。

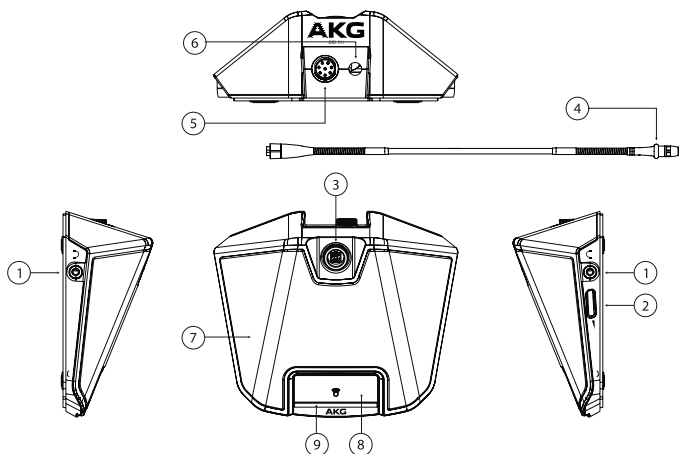
规格

CS3 DU 代表单元	
电源	DC24V (主机供电)
功率消耗	3W
扬声器功率	2W
信噪比 (S/N)	>80dB
频率响应	50Hz - 20kHz
通信接口	8芯专用接口
耳机输出	9dBu, 8-32ohm, 3.5mm
串音衰减	>80dB
谐波失真	<0.1%
尺寸	170L x 143W x 63H (mm)
重量	约1kg
工作温度	0°C到40°C, 95%相对湿度 (非冷凝)

5 使用CS3会议系统



注意

请在使用本会议系统前，正确连接系统并设置好各话筒的ID。

设置话筒单元ID

在一套CS3会议系统中，我们需要对每台话筒单元设置唯一的ID，以供控制主机识别。操作如下：

1. 正确连接CS3会议系统后，开启控制主机CS3 BU的电源。
2. 将控制主机后面板上的ID开关，拨至“ON(开启)”位置。
3. 按下一台话筒单元上的发言按键 ，当发言按键指示灯点亮为红色，表示已成功设置好本台话筒的ID。
4. 按照步骤3逐一设置余下话筒的ID。
5. 待设置完所有话筒的ID后，将控制主机上的ID开关拨至“OFF(关闭)”。此时，所有设置成功话筒的发言按键指示灯全部由红色变为蓝色。系统进入就绪状态。

设置最多代表话筒发言数



最多代表话筒发言数的设置在不同会议模式下的表现并不同。在自由模式下，此功能设置无效。有关各种模式下此设置的表现，请阅读第21页的“接口和控制”。



注意

建议您先评估所需同时发言的代表话筒数量，设置最多代表话筒发言数后，再选择会议模式。

例如，当您希望在会议中同时发言的代表数为2名，操作如下：

1. 在就绪的CS3会议系统中，按下主机上的最多代表话筒发言数  按键 选取“2”选项。相应“2”指示灯点亮。
2. 然后按下主机上的会议模式  按键 ，比如选取申请模式， 旁的指示灯被点亮。
3. 申请模式下的最多代表话筒发言数已设为2。

当在会议系统中使用了申请模式，并已设定了最多代表话筒发言数，代表话筒可以向主席话筒申请发言。

申请发言

代表话筒申请发言，操作如下：

1. 按下发言按键 。咪杆指示灯闪烁。
2. 当获得主席话筒批准后，咪杆和发言按键指示灯点亮，表示已获得批准发言，且代表话筒已进入发言状态；如果15秒后未获得批准，咪杆指示灯即熄灭并自动取消申请。

当多台代表话筒同时申请发言时，代表话筒将按先后顺序自动进入等待队列；允许最多6台代表话筒申请发言，超过6台的代表话筒申请无效，按下发言按键，代表话筒的咪杆指示灯不会闪烁。



注意

当在会议系统中使用了申请模式，并已设定了最多代表话筒发言数，主席话筒可批准代表话筒发言。

批准发言

主席话筒批准发言，操作如下：

1. 当代表话筒发出申请后，主席话筒的同意键指示灯将闪烁。
2. 按下主席话筒上的同意按键  即可批准代表话筒发言，代表话筒随即进入发言状态。

当多台代表话筒同时申请发言时，代表话筒将按先后顺序自动进入等待队列；允许最多6台代表话筒申请发言，超过6台的代表话筒申请无效，按下其发言按键，申请发言无效，主席话筒的同意键指示灯不会闪烁。





注意

按下主席话筒的同意按键，按申请的先后顺序批准代表话筒发言；同意键指示灯在批准所有申请后熄灭。



在会议中，可根据需要，使用主席单元的优先按键，

使用优先按键

暂停正在发言的代表话筒发言：

1. 短按一下主席话筒上的优先按键 ，主席话筒的咪杆和优先按键指示灯均点亮为红色，并暂停正在发言的代表单元话筒发言（该代表话筒咪杆指示灯闪烁），同时开启主席话筒发言功能。
2. 再短按一下主席话筒上的优先按键 ，恢复原发言的代表话筒发言功能，主席话筒退出优先状态（优先指示灯变为蓝色）。

取消所有代表单元的操作：

1. 长按下主席话筒上的优先按键  三秒，主席话筒的咪杆和优先按键指示灯均点亮为红色，并取消所有代表单元的操作（包括正在发言、申请发言、等待发言的操作，所有代表单元话筒咪杆指示灯熄灭），同时开启主席话筒发言功能。
2. 按下主席话筒上的发言按键 ，主席话筒退出发言并恢复到就绪状态（发言按键指示灯变为蓝色）。短按一下主席话筒上的优先按键 ，主席话筒退出优先状态（优先指示灯变为蓝色）。

Microphones · Headphones · Wireless Microphones · Wireless Headphones · Headsets · Electroacoustical Components
话筒 · 耳机 · 无线话筒 · 无线耳机 · 耳机套件 · 电子声学部件

AKG Acoustics GmbH

Lemböckgasse 21–25, A-1230 Vienna/AUSTRIA, phone: (+43-1) 86654-0*
e-mail: sales@akg.com

For other products and distributors worldwide visit www.akg.com
有关其它产品和全球经销商，请访问：www.akg.com



Specifications subject to change without notice. 本说明书中的规格如有改变恕不另行通知。

Printed in China

03/13/5024586

AKG[®]
by HARMAN