

NXAMP MK2 POWERED TD CONTROLLER

NXAMP4x1MK2

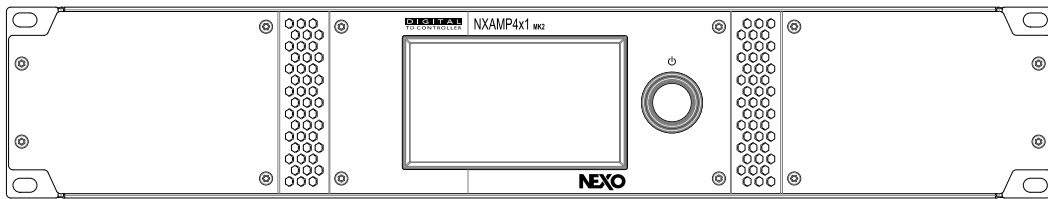

NXAMP4x2MK2

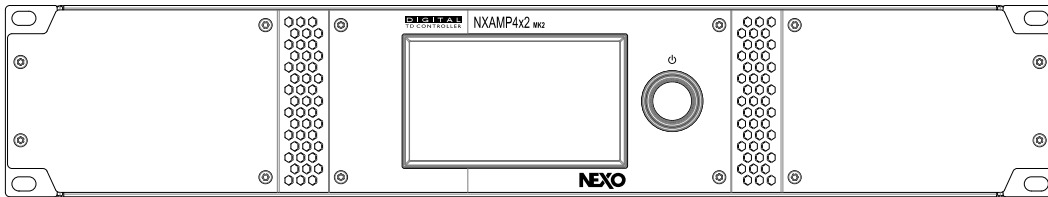

NXAMP4x4MK2

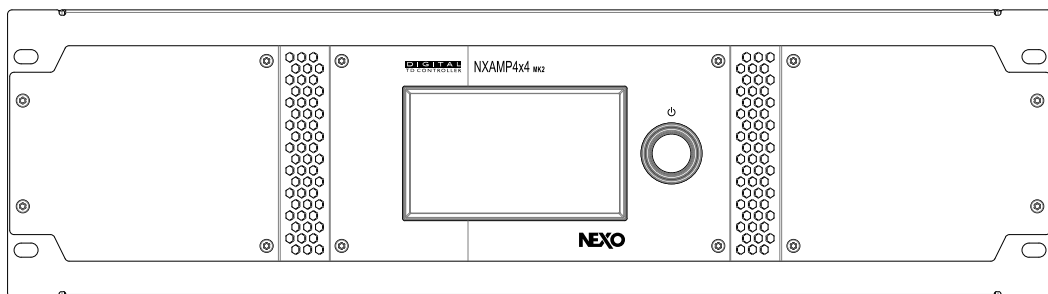

USER MANUAL (LOAD5_06)



TABLE OF CONTENTS	
TABLE OF CONTENTS	2
SAFETY PRECAUTIONS	5
SAFETY INSTRUCTIONS	5
PRECAUTIONS	6
POWER SUPPLY/POWER CORD.....	6
WATER WARNING.....	6
IF YOU NOTICE ANY ABNORMALITY.....	6
LOCATION.....	6
CONNECTIONS.....	7
MAINTENANCE.....	7
HANDLING CAUTION.....	7
COMPLIANCE INFORMATION	8
FCC INFORMATIONS (U.S.A.)	8
IMPORTANT NOTICE: DO NOT MODIFY THIS UNIT!.....	8
IMPORTANT.....	8
NOTE.....	8
DOC.....	9
INFORMATION.....	10
PACKAGING	10
INTRODUCTION	10
RACK INSTALLATION.....	10
SPEAKER CABLE CHOICE.....	11
FRONT PANEL DESCRIPTION	11
A: AIR INTAKES.....	11
B: 4.3 INCHES COLOR TOUCH SCREEN.....	11
C: ROTARY ENCODER.....	11
BACK PANEL DESCRIPTION	12
A: POWER OUTPUTS.....	12
B: EXPANSION SLOT.....	13
C: BALANCED AUDIO INPUTS.....	13
D: MAINS CONNECTORS.....	13
E: AIR EXHAUST.....	14
F: RS-232 PORT.....	14
G: GPIO PORT.....	14
AUDIO INPUT AND OUTPUT CONNECTIONS.....	15
START-UP	15
OPERATION (USING THE MENU)	17
MENU DESCRIPTIONS.....	17
OPTIONS.....	17
RESETTING TO FACTORY SETTINGS.....	18
SETTINGS MENU	19
DEFAULT VU-METER MENU DESCRIPTION.....	19
SELECTING THE PROPER SPEAKER PRESET.....	20
INPATCH AND OUTPATCH.....	21
CHECKING THE OUTPUT PATCH.....	21
VOLUME.....	21
DELAY.....	22
GAIN.....	22
ARRAY-EQS.....	23
EQ.....	23
USING THE AMPLIFIER WITHOUT THE TDCONTROLLER FUNCTIONALITY.....	26
HEADER MENU	26

TABLE OF CONTENTS

SCENE 27
 TO SAVE A SCENE: 27
 TO RECALL A SCENE 28
 SYSTEM HEADROOM 29
 LOG 29
 GLOBAL 30
 PER CHANNEL 30
OPTIONS 31
 ALERTS 31
 LOAD MONITORING 31
 MONITORING MODE 32
 FREQUENCY 33
 LEVEL 33
 IMPEDANCE HIGH AND LOW LIMITS 33
 MEASURED IMPEDANCE 33
 SCREEN & APPEARANCE 34
 LOCK AND SLEEP SETTINGS 34
 REMOTE CONTROL SETTINGS 34
 IMPORTANT NOTE 34
 DEVICE ID 35
 NAME 35
 MODE 35
 IP ADDRESS / NETMASK: 36
 ANALOG FALLBACK: 36
 GROUPS AND ZONES: 38
 GPIO SETUP 39
 GPIO CONFIGURATION 39
 INPUT PINS CONFIGURATION 40
 OUTPUT PINS CONFIGURATION 41
 DEVICE INFORMATION 42
 DELAY UNIT 43
 OUT MODE 43
 ENERGY SAVER ENABLED 44
 DPU MODE 44
ALERTS LIST 44
 GLOBAL 44
 MAINS1 VOLTAGE(V) 44
 MAINS2 VOLTAGE(V) – ONLY 4X4 44
 POWER SUPPLY1 VOLTAGE(V) 44
 POWER SUPPLY2 VOLTAGE(V) – ONLY 4X4 44
 POWER SUPPLY1 OVERTEMPERATURE 45
 POWER SUPPLY2 OVERTEMPERATURE – ONLY 4X4 45
 AMPLIFIER MUTING OUTPUT 45
 FAN1 ERROR 45
 FAN2 ERROR 45
 FAN3 ERROR 46
 ANALOG FALLBACK 46
 MAINS NOT CONNECTED – ONLY 4X4 46
 PER CHANEL 46
 POWER AMP DC OUTPUT ALERT 46
 AMPLIFIER OVERTEMPERATURE LEVEL1 46
 AMPLIFIER OVERTEMPERATURE LEVEL2 46
 AMPLIFIER OVERTEMPERATURE LEVEL3 47
 AMPLIFIER OVERCURRENT ALERT 47
 HIGH LOAD ALERT 47
 LOW LOAD ALERT 47

TABLE OF CONTENTS

DPU DIGITAL PATCHING UNIT FOR NXAMP.....	47
FRONT PANEL DESCRIPTION	47
A: SPEAKON 4 POLES OUTPUT	47
B: SPEAKON 8 POLES OUTPUT	48
C: LCD DISPLAY	48
BACK PANEL DESCRIPTION.....	48
C: MAINS CONNECTORS	48
D: SPEAKON 4 POLES INPUTS.....	48
E: RS232 PORT.....	49
OPERATING THE DPU.....	49
CONNECTIONS AND START UP	49
DPU FRONT PANEL CONNECTORS ROUTING.....	50
DPU DISPLAYED INFORMATION.....	50
UNUSED FRONT PANEL CONNECTORS	52
LINKING SEVERAL DPU TOGETHER.....	52
REMOTE CONTROL – NEXO NEMO.....	53
IP BASED REMOTE CONTROL PROTOCOL.....	53
NEMO (NEXO REMOTE): NXAMPMK2 CONTROL SOFTWARE	54
OTHER REMOTE-CONTROL OPTIONS.....	55
FIRMWARE UPDATE – NEXO NEFU.....	55
ACCESSORIES	57
NXDT104MK2	57
NXES104	57
NXAE104	57
NXRM104	57
DMU.....	58
DPU	58
MAINTENANCE.....	59
TECHNICAL SPECIFICATIONS	60
THERMAL DISSIPATION AND CURRENT DRAWN	61
NXAMP4X1MK2 (PINK NOISE, 100 V/50 HZ MAINS).....	61
NXAMP4X1MK2 (PINK NOISE, 120 V/60 HZ MAINS).....	61
NXAMP4X1MK2 (PINK NOISE, 230 V/50 HZ MAINS).....	62
NXAMP4X2MK2 (PINK NOISE, 100 V/50 HZ MAINS).....	62
NXAMP4X2MK2 (PINK NOISE, 120 V/60 HZ MAINS).....	63
NXAMP4X2MK2 (PINK NOISE, 230 V/50 HZ MAINS).....	63
NXAMP4X4MK2 (PINK NOISE, 100 V/50 HZ MAINS).....	64
NXAMP4X4MK2 (PINK NOISE, 120 V/60 HZ MAINS).....	64
NXAMP4X4MK2 (PINK NOISE, 230 V/50 HZ MAINS).....	65
DRAWINGS AND DIMENSIONS.....	66
LOG AND ALERT PARAMETERS	67
LICENSE INFORMATION	69
GOOGLE ROBOTO FONT.....	69
LWIP – LIGHTWEIGHT IP STACK.....	69
WEEE INFORMATION	70
INFORMATION FOR USERS ON COLLECTION AND DISPOSAL OF OLD EQUIPMENT:	70
VERBRAUCHERINFORMATION ZUR SAMMLUNG UND ENTSORGUNG ALTER ELEKTROGERÄTE:	70
INFORMATIONS CONCERNANT LA COLLECTE ET LE TRAITEMENT DES DECHETS D'EQUIPEMENTS ELECTRIQUES ET ELECTRONIQUES	71
INFORMACION PARA USUARIOS SOBRE LA RECOGIDA Y ELIMINACION DE LOS EQUIPOS ANTIGUOS	71
USER NOTES.....	72

SAFETY PRECAUTIONS

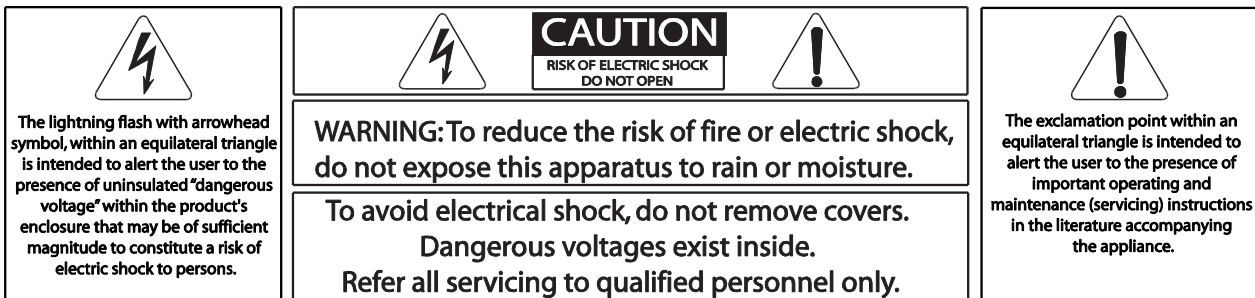

The above warning is located on the top of the unit.

SAFETY INSTRUCTIONS

Read this manual before using the TD Controller.

Keep this manual available for further reference.

Observe all warnings and cautions.

Follow all instructions.

Do not use this apparatus near water;

Clean only with dry cloth.

Do not block any ventilation opening, install in accordance with the manufacturer's instructions.

Do not install near any heat sources such as radiators, heat registers, stoves, or other apparatus (including amplifiers) that product heat.

Do not defeat the safety purpose of the polarized or grounding-type plug. A polarized plug has two blades and a third grounding prong. The wide blade or the third prong are provided for your safety. If the provided plug does not fit into your outlet, consult an electrician for replacement of the obsolete outlet.

Protect the power cord from being walked on or pinched particularly at plugs, convenience receptacles, and the point where they exit from the apparatus.

Only use attachments/accessories specified by the manufacturer.

Use only with the cart, stand, tripod, bracket, or table specified by the manufacturer, or sold with the apparatus. When a cart is used, use caution when moving the cart/apparatus combination to avoid injury from tip-over.

Unplug this apparatus during lightning storms or when unused for long periods of time.

Refer all servicing to qualified service personnel. Servicing is required when the apparatus has been damaged in any way, such as power-supply cord or plug is damaged, liquid has been spilled or exposed to rain or moisture, does not operate normally, or has been dropped.

Please check the NEXO Web site nexo-sa.com to get the most up-to-date version of this manual.

Ensure you are aware of the safety rules applying to rigging, stacking or installing on tripod or speaker stand. Failure to observe these rules may expose persons to potential wounds or even death.

Only use the system with accessories specified by NEXO.

Please always consult a NEXO-accredited technician if the installation needs architectural works and observe following precautions:



Please check regularly the system condition.

PRECAUTIONS

Please read carefully before proceeding. Please keep this manual in a safe place for future reference.

WARNING!

Always follow the basic precautions listed below to avoid the possibility of serious injury or even death from electrical shock, short-circuiting, damages, fire or other hazards. These precautions include, but are not limited to, the following:

POWER SUPPLY/POWER CORD

Only use the voltage specified as correct for the device. The required voltage is printed on the name plate of the device.

Use only the included power cord if any. If you intend to use the device in an area other than the one you purchased, the included power cord may not be compatible. Please check with NEXO.

Do not use the included power cord for other devices.

Do not place the power cord near heat sources such as heaters or radiators, and do not excessively bend or otherwise damage the cord, place heavy objects on it, or place it in a position where anyone could walk on, trip over, or roll anything over it.

Be sure to connect to an appropriate outlet with a protective grounding connection. Improper grounding can result in electrical shock.

Remove the electric plug from the outlet when the device is not to be used for extended periods of time, or during electrical storms.

When removing the electric plug from the device or an outlet, always hold the plug itself and not the cord. Pulling by the cord can damage it.

To disconnect this device from the mains, unplug the power cord.

Even when the Standby/On switch is in standby status (display is off), electricity is still flowing to the instrument at the minimum level. When you are not using the instrument for a long time, make sure you unplug the power cord from the wall AC outlet.

Do not open the device, do not try to disassemble it neither to modify it in any way. The system doesn't include any user-serviceable parts. If the system seems to be malfunctioning or damaged, stop using it at once and have it repaired by a NEXO qualified personnel.

WATER WARNING

Do not expose the system directly to the rain, do not immerse it into fluids, do not place objects filled with liquid on the system. If a liquid gets into the device, turn off the power immediately and unplug the power cord from the AC outlet. Then have it inspected by a NEXO qualified technician.

Never insert or remove an electric plug with wet hands.

IF YOU NOTICE ANY ABNORMALITY

If the power cord or plug becomes frayed or damaged, or if there is a sudden loss of sound during use of the device, or any unusual smells or smoke should appear to be caused by it, immediately turn off the power switch, disconnect the electric plug from the outlet, and have the device inspected by qualified NEXO service personnel.

If this device should be dropped or damaged, immediately turn off the power switch, disconnect the electric plug from the outlet, and have the device inspected by qualified NEXO service personnel.

LOCATION

Before moving the device, remove all connected cables.

When setting up the device, make sure that the AC outlet you are using is easily accessible. If some trouble or malfunction occurs, immediately turn off the power switch and disconnect the plug from the outlet.

SAFETY PRECAUTIONS

If this device is to be mounted in an EIA-standard rack, leave the back of the rack open and make sure that it is at least 10 cm away from walls or surfaces. Also, if the device is to be mounted with devices that tend to generate heat, such as power amplifiers, be sure to keep an adequate gap between this device and the heat-generating devices or install ventilation panels to prevent high temperatures from developing inside this device.

Inadequate ventilation can result in overheating, possibly causing damage to the device(s), or even fire.

Do not use in a confined, poorly-ventilated location. If this device is to be used in a small space other than an EIA-standard rack, make sure that there is adequate space between the device and surrounding walls or other devices: at least 10 cm at the sides, 15 cm behind and 40 cm above.

Inadequate ventilation can result in overheating, possibly causing damage to the device(s), or even fire.

Do not place the device in a location where it may come into contact with corrosive gases or salt air. Doing so may result in malfunction.

Do not expose the device to excessive dust or vibrations, or extreme cold or heat (such as direct sunlight, near a heater, or in a car during the day) to prevent the possibility of panel disfiguration or damage to the internal components.

Do not place the device in an instable position where it might accidentally fall over.

Do not block the vents. This device has ventilation holes at front and back to prevent the internal temperature from becoming too high. In particular, do not place the device on the front or the back. Inadequate ventilation can result in overheating, possibly causing damage to the device(s), or even fire.

Do not use the device in the vicinity of a TV, radio, stereo equipment, mobile phone, or other electric devices. Doing so may result in noise, both in the device itself and in the TV or radio next to it.

Keep the device out of reach of children, to keep them from putting their fingers into openings on the equipment and accidentally being injured.

CONNECTIONS

Before connecting the device to other devices, turn off the power for all devices. Before turning the power on or off for all devices, set all volume levels to minimum.

Use only speaker cables for connecting speakers to the speaker jacks. Use of other types of cables may result in fire.

XLR-type connectors are wired as follows (IEC60268 standard): pin 1: ground, pin 2: hot (+) and pin 3: cold (-).

Use only speakON NL4 plugs for connecting SP connectors.

MAINTENANCE

Inspect the ventilation holes and clean them periodically. Dust and dirt can seriously degrade the effectiveness of the cooling and result in malfunction or fire.

Remove the power plug from the AC outlet when cleaning the device.

The performance of components with moving contacts, such as switches, volume controls, and connectors, deteriorates over time. Consult qualified NEXO service personnel about replacing defective components.

HANDLING CAUTION

When turning on the AC power in your audio system, always turn on the device LAST, to avoid speaker damage. When turning the power off, the device should be turned off FIRST for the same reason.

Do not insert your fingers or hands in any gaps or openings on the device (vents...).

Avoid inserting or dropping foreign objects (paper, plastic, metal, etc.) into any gaps or openings on the device (vents, etc.) If this happens, turn off the power immediately and unplug the power cord from the AC outlet. Then have the device inspected by qualified NEXO service personnel.

Do not use the device for a long period of time at a high or uncomfortable volume level, since this can cause permanent hearing loss. If you experience any hearing loss or ringing in the ears, consult a physician.

COMPLIANCE INFORMATION

Do not rest your weight on the device or place heavy objects on it, and avoid use excessive force on the buttons, switches or connectors.

Do not use this device for any purpose other than driving loudspeakers.

Rapidly turning the unit on and off in succession can cause it to malfunction. After turning the unit off, wait for more than five seconds before turning it on again.

⚠ WARNING!

This ⚡ mark indicates a dangerous electrically live terminal. When connecting an external wire to this terminal, it is necessary either to have “a person who have received appropriate guidance on handling” make the connection or to use leads or a cord that have been manufactured in such way that the connection can be made simply and without problem.

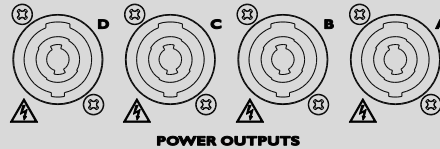

COMPLIANCE INFORMATION

FCC INFORMATIONS (U.S.A.)

IMPORTANT NOTICE: DO NOT MODIFY THIS UNIT!

This product, when installed as indicated in the instructions contained in this manual, meets FCC requirements. Modifications not expressly approved by NEXO-SA may void your authority, granted by the FCC, to use the product.

IMPORTANT

When connecting this product to accessories and/or another product use only high-quality shielded cables. Cable(s) supplied with this product MUST be used. Follow all installation instructions. Failure to follow instructions could void your FCC authorization to use this product in the USA.

NOTE

This product has been tested and found to comply with the requirements listed in FCC Regulations, Part 15 for Class “A” digital devices. Compliance with these requirements provides a reasonable level of assurance that your use of this product in a residential environment will not result in harmful interference with other electronic devices. This equipment generates/uses radio frequencies and, if not installed and used according to the instructions found in the user manual, may cause interference harmful to the operation of other electronic devices. Compliance with FCC regulations does not guarantee that interference will not occur in all installations, which can be determined by turning the unit “OFF” and “ON”, please try to eliminate the problem by using one of the following measures:

Relocate either this product or the device that is being affected by the interference.

Utilize power outlets that are on different branch (circuit breaker or fuse) circuits or install AC line filter(s).

In the case of radio or TV interference, relocate/reorient the antenna. If the antenna lead-in is 300 Ohms ribbon lead, change the lead-in to co-axial type cable.

If these corrective measures do not produce satisfactory results, please contact the local retailer authorized to distribute this type of product. If you cannot locate the appropriate retailer, please contact the After Sales department of NEXO-SA, Parc d'Activité du Pré de la Dame Jeanne, B.P.5, 60128 PLAILLY, FRANCE.

COMPLIANCE INFORMATION

This product contains a battery that contains perchlorate material.
Perchlorate Material – Special handling may apply.
See www.dtsc.ca.gov/hazardouswaste/perchlorate.

(Perchlorate)

This applies only to the products distributed in the United States of America.

DOC

Declaration of Conformity

We,	NEXO SA
	ZA DU PRE DE LA DAME JEANNE
	60128 PLAILLY – France
Declare under our sole responsibility that the product	TD Controller
Type	NXAMP4x1mk2, NXAMP4x2mk2, NXAMP4x4mk2
Serial number	On the product
Is in conformity with the provisions of the following directive including all applicable amendments:	2014/35/UE (Low Voltage Directive) 2014/30/EU (EMC) 2011/65/EU (RoHS) EN 55103-1:2009 + A1:2012 EN55103-2:2009 + IS:2012 FCC Part 15:2013 This device complies with Part 15 of the FCC Rules. Operation is subject to the following two conditions: 1) this device may not cause harmful interference, and 2) this device must accept any interference received including interference that may cause undesired operation. See user manual instructions if interference to radio reception is suspected. EN60065:2002 + A1:2006 + A11:2008 + A2:2010 + A12:2011 IEC60065 (ed7) + AM1 + AM2, including national differences for EU, AU, CA, JP, US CSA and CCC Certification
Plailly, March 02 th , 2017	Joseph CARCOPINO, R&D Director



INFORMATION

European models

Purchaser/User information specified in EN55103-2:2009.

Conforms to Environments: E1, E2, E3 and E4.

The model number, serial number, power requirements, etc., be found on or near the name plate, which is at the top of the unit. You should note this serial number in the space provided below and retain this manual as a permanent record of your purchase to aid identification in the event of theft.

Model No

Serial No

PACKAGING

⚠ WARNING!

The shipping weight of the NXAMP4x1mk2 is nearly 20kg (44 lb)

The shipping weight of the NXAMP4x2mk2 is nearly 20kg (44 lb)

The shipping weight of the NXAMP4x4mk2 is nearly 29kg (64 lb)

Because of the large size of the carton box it is recommended to manipulate it with two persons.

Open the box with care to prevent damage on the content. Inside you will find:

- NXAMPmk2 Powered TDController with NXRM104 card fitted.
- 1 x NXAMPmk2 Quick Start guide
- 1 x powerCon 20A to CEE form 32A mono (for NXAMP4x1mk2 & NXAMP4x2mk2) or 2 x PowerCon 20A to CEE form 32A mono (for NXAMP4x4mk2).

INTRODUCTION

Welcome to the NXAMPmk2 manual. Please take some time to read it and learn how to set up the device.

The NXAMPmk2 is a range of four-channel powered TD Controller developed to perfectly match the NEXO range of speakers.

A TD Controller is a highly sophisticated audio processing unit, design to enhance the sonic performances as well as to protect the NEXO speakers. This processor is coupled with four channels of power amplifier.

RACK INSTALLATION

The NXAMPmk2 should be mounted into a suitable rack unit, ensuring both front and rear mounting holes are used in order to protect the device from mechanical damage.

Air flow of the NXAMPmk2 is from front to back, thus installation can mix DTDAMP (with DTD Controller), first generation NXAMP and NXAMPmk2 in the same rack, all using the same air flow direction.

SPEAKER CABLE CHOICE

⚠ WARNING!

High voltage can be present on the power amplifier output terminals. Use at least NEC (National Electrical Code) UL13 CL3 (under 300V) wiring cable to connect the NXAMPmk2 to the NEXO speakers.

To minimize power and damping factor losses in speaker cable, use suitable gauges from the table below.

Load Impedance (Ohms)	2	2.6	4	8
Cable section	Maximum length in meters (feet)			
2.5 mm ² (AWG #13)	20 (66)	28 (92)	40 (130)	80 (260)
4 mm ² (AWG #11)	32 (105)	40 (130)	64 (210)	128 (420)
6 mm ² (AWG #9)	48 (160)	64 (210)	96 (315)	192 (630)

FRONT PANEL DESCRIPTION

The NXAMPmk2 features a color 4.3 inches touch screen display and a pushable rotary encoder with a surround backlight.

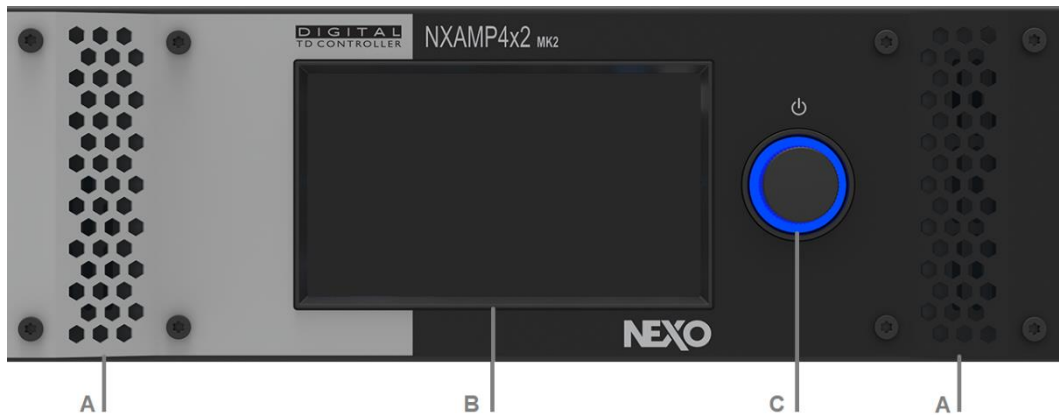

A: AIR INTAKES

The NXAMPmk2 uses forced-air cooling. The variable speed cooling fan draws air in from the front and exhausts it through the rear. Please be sure that you do not block the air intakes or exhaust vents.

B: 4.3 INCHES COLOR TOUCH SCREEN

The large tactile screen is used for the display of the amplifier settings and status. Use the Up/Down arrow to navigate into the menus, select an area to adjust a parameter and turn or press the encoder accordingly.

C: ROTARY ENCODER

INTRODUCTION

The NXAMPmk2 setup is straightforward. Once all the wiring has been done and mains is present, the surround backlight of the encoder is glowing slowly. Long press this encoder till the system boots up. The first screen will show the NEXO logo and the revision of the firmware starting with "LOAD".



The rotary encoder is also used to navigate in the menu or to validate a value when you press it.

BACK PANEL DESCRIPTION

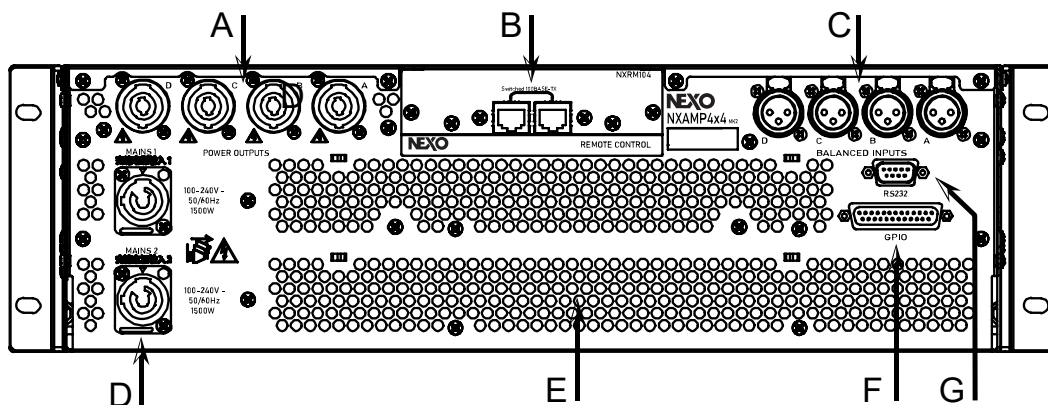

A: POWER OUTPUTS

The NXAMPmk2 uses four NL4 outputs to connect the speakers. The pin out is the following:

- Amplifier CH1 (or CH2*) outputs on NL4 A 1+/1- and NL4 B 2+/2-
- Amplifier CH2 (or CH1*) outputs on NL4 B 1+/1- and NL4 A 2+/2-
- Amplifier CH3 (or CH4*) outputs on NL4 C 1+/1- and NL4 D 2+/2-
- Amplifier CH4 (or CH3*) outputs on NL4 D 1+/1- and NL4 C 2+/2-

(*) The NXAMPmk2 optimizes the output pinout depending on the setup used. Please check front panel indication to know where to connect your NEXO speaker.

NXAMPmk2 outputs can be bridged two by two. Note that there is no dedicated output to use the amplifiers in bridge mode, bridge being always available with the following pinout:

- Amplifier CH1&2 (bridge) outputs on NL4 A 1+/1- and NL4 B 2+/2-
- Amplifier CH2&3 (bridge) outputs on NL4 C 1+/1- and NL4 D 2+/2-

⚠ WARNING!

When used in bridge mode, never touch or short-circuit the unused pins on the output NL4 as some high voltage can be present.

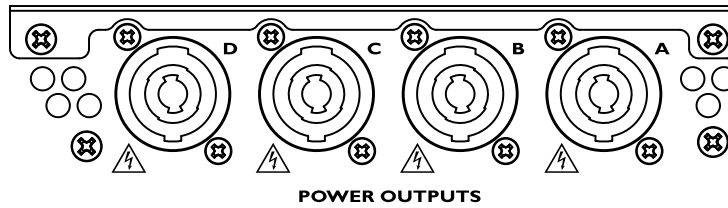

To help you connect seamlessly the NXAMPmk2 to your NEXO speakers, an automatic Digital Patch Unit (reference DPU) is available.

Please check the speaker impedance before connecting to the NXAMPmk2.

⚠ WARNING!

The NXAMPmk2 works with output load down to 2 Ohms in four channels mode or down to 4 Ohms in bridge mode.

B: EXPANSION SLOT

Through the expansion slot located in the middle of the back panel of the NXAMPmk2, the default network based remote control card can be replaced by a digital audio input and network remote control card.

At the time of writing, AES/EBU, EtherSound™, Dante™ (and AES67) digital audio format are supported through expansion boards (See [Accessories](#) section).

Use STP (Shielded Twisted Pair) cable to prevent electromagnetic interference. Make sure that the metal parts of the plugs are electrically connected to STP cable shield by conductive tape or comparable means.

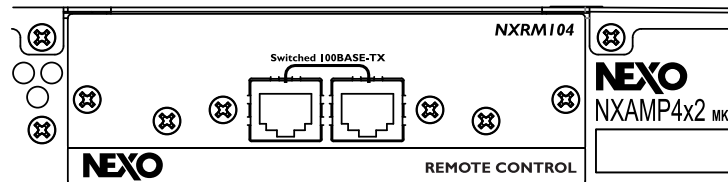

C: BALANCED AUDIO INPUTS

Use the back panel female XLR3 connectors to connect the balanced analog input signal, typically from an audio mixer output.

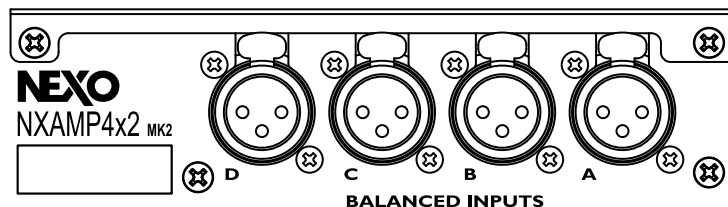

To help you connect seamlessly the NXAMPmk2 to your analog or network inputs, including metering, a Digital Metering Unit (reference DMU) is available.

D: MAINS CONNECTORS

The NXAMPmk2 can accept Mains from 100 to 240 Volts, both 50 to 60 Hz, thanks to its high efficiency active PFC (Power Factor Correction) system.

⚠ WARNING!

Check the local mains value and ensure that fits the needs of the NXAMPmk2 before connecting.

Refer to the specification page of this document to know the main power requirement of the NXAMPmk2 depending on the NXAMPmk2 model and the load connected.

The mains connection is done through standard PowerCon 20 connector.

E: AIR EXHAUST

F: RS-232 PORT

This serial port is used to connect a NEXO DPU (Digital Patching Unit) device. Note that It is not possible to upgrade the NXAMPmk2 firmware though this serial port.

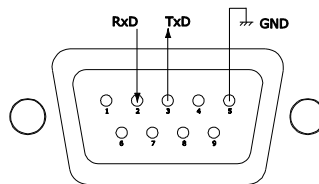

View from the back of the amplifier

The RxD pin is the “Receive data” pin from the NXAMP point of view. Thus, this is an input. The TxD pin is the “Transmit data” pin from the NXAMP point of view. Thus, this is an output. GND is the ground.

A crossover cable (connecting RxD pin of NXAMP to TxD pin of the DPU, and so on) is needed to use this serial port with the NEXO DPU device. Please see DPU user manual for further details.

G: GPIO PORT

This GPIO port is used for interfacing the amplifier to security system, or to allow a basic remote control of the device. NEXO DMU (Digital Meters Unit) device also connects here.

There are the following signals available:

- 8 x General purpose output signals from NXAMP (5 Volts signals)
- 5 x General purpose input signals to NXAMP (5 Volts signals)
- 4 x 5 Volts outputs
- 8 x GND (ground) signals.

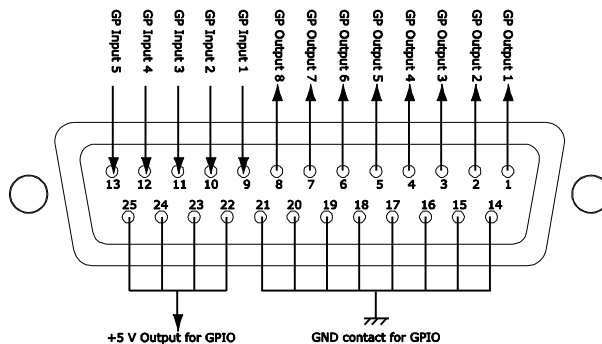

View from the back of the amplifier

⚠ WARNING!

It is mandatory to have a galvanic isolation between these signals and any another equipment. Thus, either the target equipment should present isolated GPIO system, or the signal should go through small signal relays to guarantee that the NXAMP GPIO will be isolated from the other equipment.

START-UP

The maximum current available on the GPIO port is the following:

- Maximum 200 mA drawn from the totality of the +5 V outputs.
- Maximum 200 mA drawn from the totality of the GP Outputs, with a maximum of 32 mA for each output.

AUDIO INPUT AND OUTPUT CONNECTIONS

Place the NXAMPmk2 in the audio chain just before the NEXO speakers, typically at the output of the mixer or matrix.

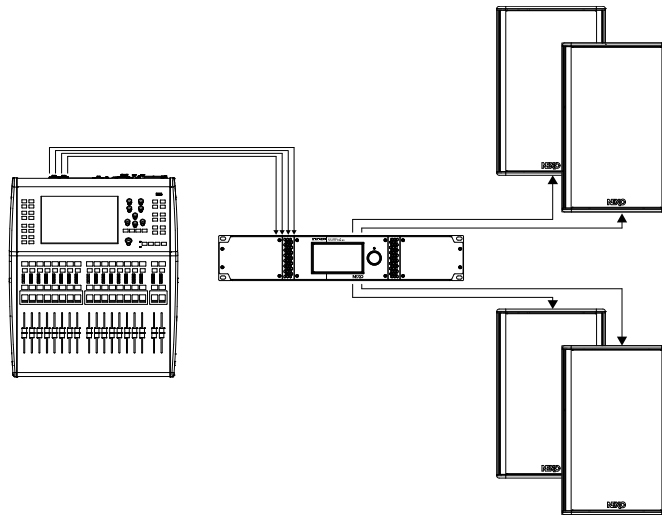

⚠ WARNING!

Unplug the device from mains before connecting or disconnecting any cable to it.

START-UP

The NXAMPmk2 setup is straightforward. Once all the wiring has been done and mains is present, the surround backlight of the encoder is glowing slowly. Long press this encoder till the system boots up.



When no parameter is selected, press the encoder to enter the option menu. Turn the encoder to select an option or press the back button to go to main menu again.

After a few seconds, the default Settings Menu displaying Vue-meters for each channel is displayed, see screenshot below. The settings menus are described further in this manual.

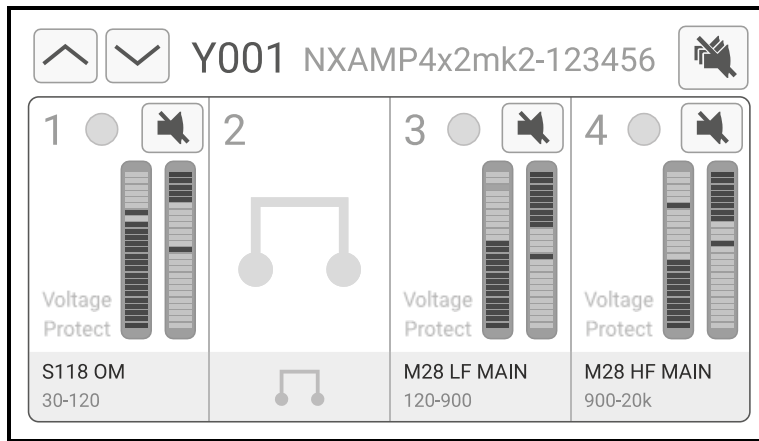

From one of the Settings Menus, The Header Menu pictured below is entered by pressing the encoder.

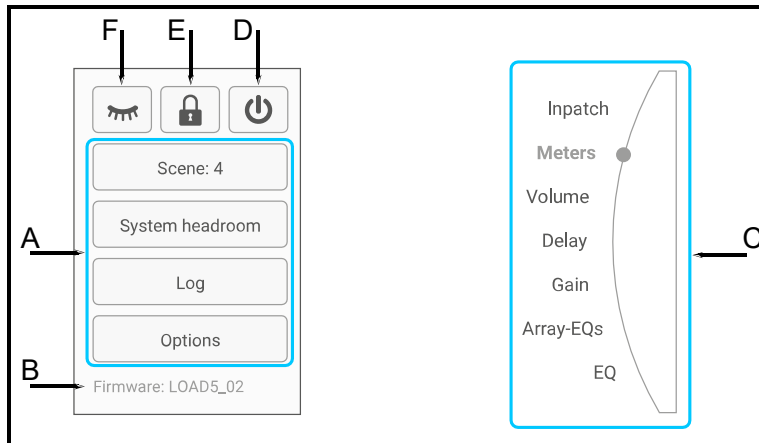

- A: INTERNAL MENU
- B: FIRMWARE VERSION
- C: SETTINGS MENU
- D: STAND-BY
- E: LOCK THE DEVICE
- F: SHOW INACTIVE SCREEN

OPERATION (USING THE MENU)

MENU DESCRIPTIONS

Push on the rotary encoder to access the Header Menu.

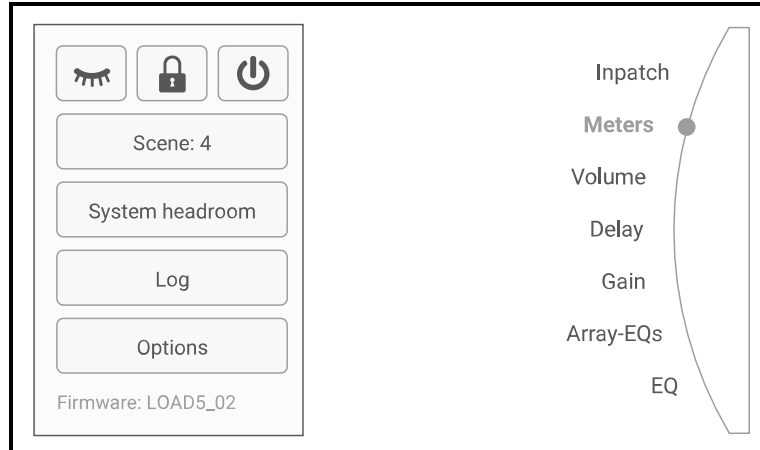

Turn the rotary encoder to select an item, press the rotary encoder to enter in the sub-menu.

If you are already in the sub-menu, you can also select by using the arrows in the top left of the touchscreen.

- **Inpatch:** The inputs view displays input levels and offer input time alignment options. Operations are detailed below.
- **Meters:** Voltage and Protection Meters give relevant information on system Headroom.
- **Volume:** Edit volume (-90 to 0dB) on one or several channels at once.
- **Delay:** Edit delay (up to 1 second) on one or several channels at once.
- **Gain:** Edit gain (-18 to +18 dB) on one or several channels at once.
- **Array EQs:** Two settings of Array-EQ allow for a better compensation of ground, stacking and line-array effect, on Low and High frequencies.
- **EQ:** In addition to cabinet-related EQ and Array EQ. User EQ provides up to 8 bands per channel, editable on one or several channels at once. Operations are detailed below.

On the left-hand-side of the Header Menu, you have direct access to:

- **Scene:** Parameters (volume, delay, gain, EQ, input patch, setup...) can be saved in one of the 32 scene slots and can be copied and pasted.
- **System headroom:** The system headroom page gives real-time information on amplifier levels and speaker temperature, displacement, and protection levels.
- **Log:** Many parameters and alerts are always recorded into the log, providing valuable information on the NXAMPmk2 usage.
- **Options:** See options list below.

OPTIONS

- **Alerts:** See [Alerts List](#).
- **Load Monitoring:** Load Monitoring can be enabled and configured on every channel, to ensure speakers are monitored in real time and ready to use.
- **Screen & Appearance:** Allows you to customize the screen (background image, tint color and luminosity)
- **Lock and Sleep Settings:** Allows you to lock the device with a password, manage the screen saver;
- **Remote Control Settings:** Displays the IP address of the amplifier and other network related settings.

- Groups and Zones: Defines the preferred remote client, the Group name, and the channels Zones.
- GPIO Setup: Adjusts the function attached of each GPIO pins on the back of the amplifier.
- Device Information: Serial Number, Firmware, Main, Boot, Boot2
- Delay Unit: Selects the delay unit between milliseconds, meters, and feet.
- Out Mode: Selects the output speakON routing options of the NXAMPmk2.
- Energy Saver Enabled: Reduces the amplifier power consumption when not in used.
- DPU Mode: If a NEXO DPU unit is connected, select the preferred routing algorithm.

RESETTING TO FACTORY SETTINGS

To reset to factory Settings, keep the encoder button pushed while resuming from standby status.

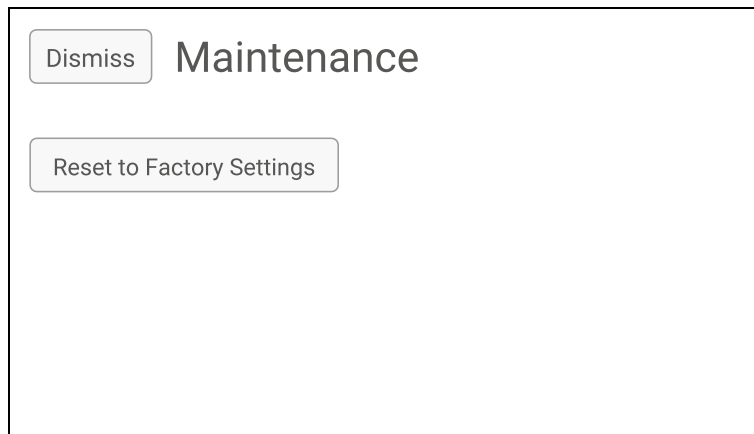

By selecting Continue, factory settings will be reset, and the unit will reboot.

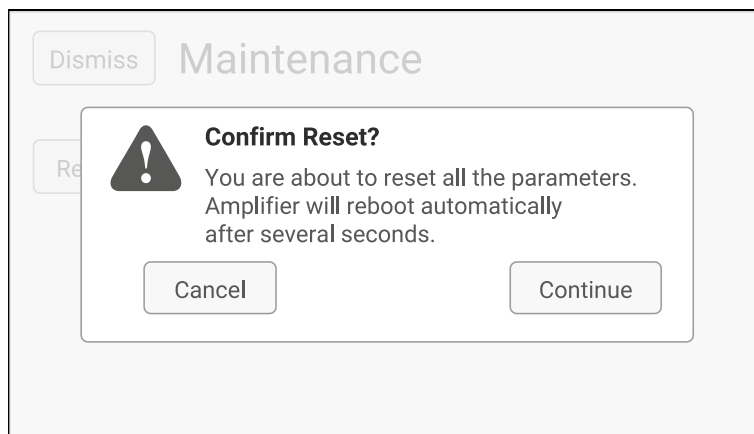

SETTINGS MENU

DEFAULT VU-METER MENU DESCRIPTION

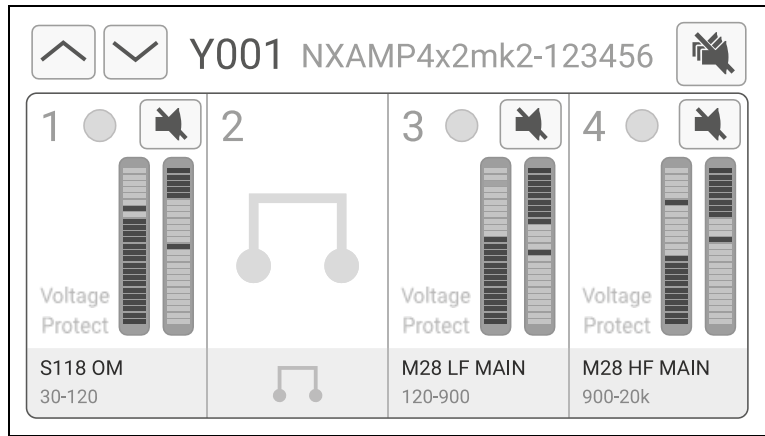
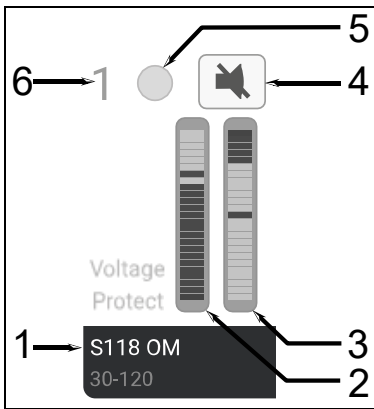

1: Speaker preset, the first line shows the Speaker name (here “S118”) and the Speaker mode if any (here “OM” for Omnidirectional) while the second line shows the selected frequency range (here 30 Hz to 120 Hz). The Speaker Mode can be one of the following:

On Screen MODE display	MODE signification
WB	Wideband setups (lower high-pass filter)
XO	Cross over setups (higher high-pass filter)
PA	Passive mode (on products providing an active/passive mode)
AC	Active mode (on products providing an active/passive mode)
MON	Monitor setups (Specific phase response, minimized latency)
BR	Bridge mode
OM	Omnidirectional mode (on products allowing Omni/Cardio switching)
CD	Cardioid mode (on products allowing Omni/Cardio switching)
FR	Channel used for Front speaker in Cardioid mode
BA	Channel used for Back speaker in Cardioid mode
B2B	Back to back mode (on products requiring two cabinets for Cardio)
S2S	Side to side mode (on products requiring two cabinets for Cardio)
DF	Down Fill (for line array used in Downfill application)

2: Vu-meter of the amplifier channel output voltage. Scale is from -60dB to 0dB (relative to the amplifier output clip).

3: Vu-meter of the gain reduction applied if the speaker protection is active. Scale is 0dB to 24dB.

4: Mute, this is an individual mute for each channel of the amplifier.

5: Dual colour led, which can be green or orange. Green means that the amplifier detects some current on the output, indicating (when there is signal) that a speaker is connected. Orange means that the speaker is being protected (when vu-meter 3 is above 0dB).

6: Channel number

SETTINGS MENU

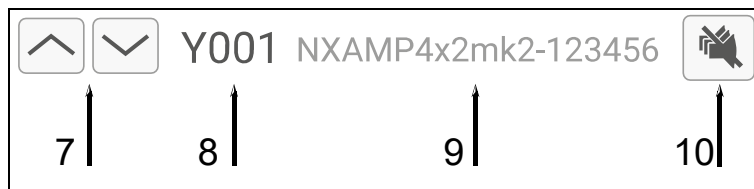

7: Menu Navigation Buttons, allows to navigate between the settings menu.

8: Device ID, to easily identify the unit on the network.

9: Device Name, more detailed name to describe the unit over the network.

10: Global Mute Button. Note: there are two layers of MUTE: One layer with individual channels mute, and one “overmute” layer (all channels).

SELECTING THE PROPER SPEAKER PRESET

Press one or several of the “Speaker preset area” (1) on the default screen to access the speaker preset.

This menu allows to select either a speaker preset for each selected channel (through the “Series”, “Cabinet”, “Mode”, and “Cross-over” button), or four-channel speaker preset arrangement provided by NEXO (through the “NEXO” button).

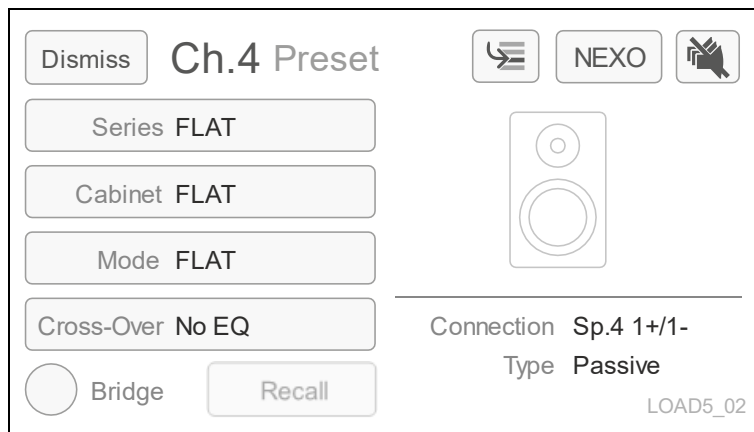

- Dismiss: To return to the previous screen without any modifications
- Recall: To return to the previous screen with the new speaker preset
- NEXO: To choose a NEXO speaker preset

INPATCH AND OUTPATCH

Once the Speakers preset have been recalled, and back to the default screen, press the “Up navigation button” (2) to enter the input patch

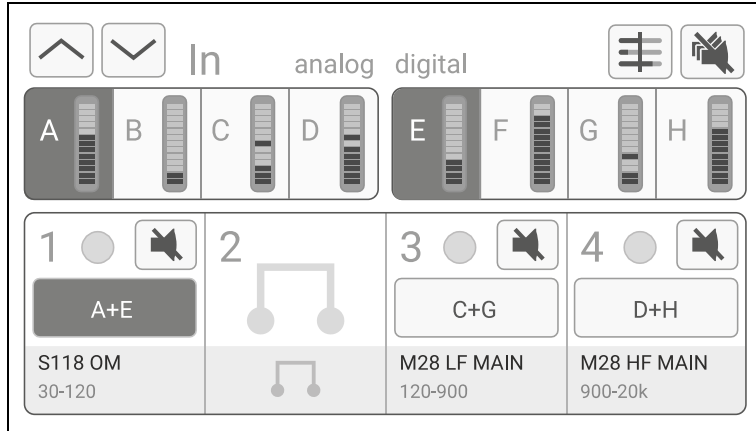

For each channel press the area just above the Speaker Preset Name (surrounded for Channel 1) and select among the eight available inputs (from A to H). Inputs A to D corresponds to the four analog inputs at the back of the amplifier, whereas the input E to H corresponds to the four digital inputs from the optional digital input card. A vu-meter is available for each input in the top part of the screen.

Additionally, an alignment delay can be added to any of the inputs (Analog or Digital) to ensure perfect matching of latency using Analog or Digital inputs, depending of your cabling architecture and source devices. This alignment delay can be setup by pressing the button just next the Global Mute Button.

CHECKING THE OUTPUT PATCH

From the default screen, the Speaker Preset Name (1) will blink alternatively with the output letter and the output pinout (1+/1- or 2+/2- of the NL4 connector). Check that the NEXO Speakers are correctly connected.

Send some low-level audio or test signal into the NXAMPmk2 and check that each Speaker or Sub is outputting a non-distorted sound (you might need to check the channel output volume first, see next paragraph).

Once this has been checked, the system is ready to use. Extra settings like Gain, delays or EQs can be applied to tune up the sound further.

VOLUME

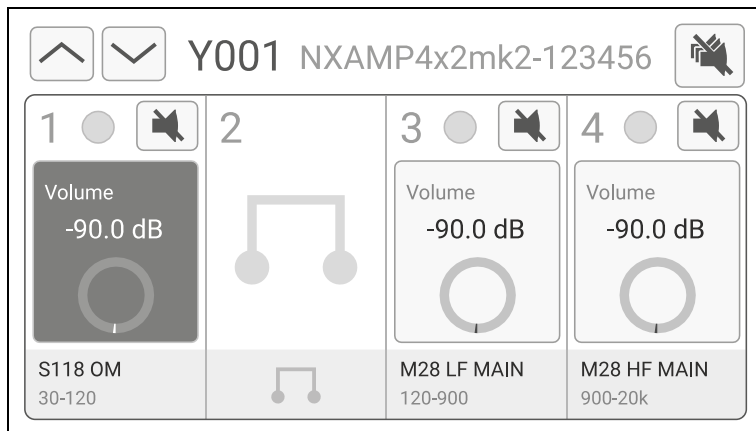

Select a channel (button is highlighted), then turn the wheel to change the volume setting. You can select multiple channels, when a selected channel reaches the maximum value, it will cease to increase by

continuing to turn the wheel, but other selected channels may still increase the setting; Be careful not to change a gap between two channel settings when selecting multiple channels at the same time.

NB: You can adjust large differences of gain between channels with the volume menu. There is no difference between gain and volume setting; this distinction is only done by analogy with traditional amplifiers. The CPU will always check gain, volume, patch and headroom settings and decide what the best combination is between analog or digital gain to optimize the dynamic range of the system.

DELAY

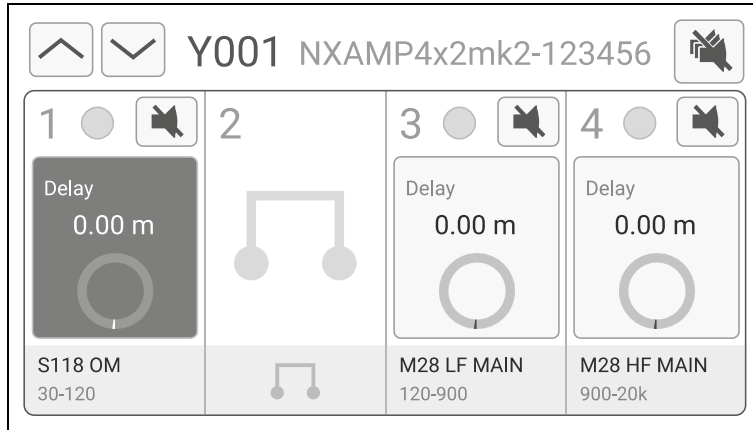

Select a channel (button is highlighted), then turn the wheel to change the delay setting.

You can select multiple channels, when a selected channel reaches the maximum value, it will cease to increase by continuing to turn the wheel, but other selected channels may still increase the setting; Be careful not to change a gap between two channel settings when selecting multiple channels at the same time.

In some special situation (active setups in same enclosure for example, like P12 active) it is mandatory to have same delay settings on two or more channels. Then changing the delay on one of these channels will automatically adjust the delays on the other channels.

GAIN

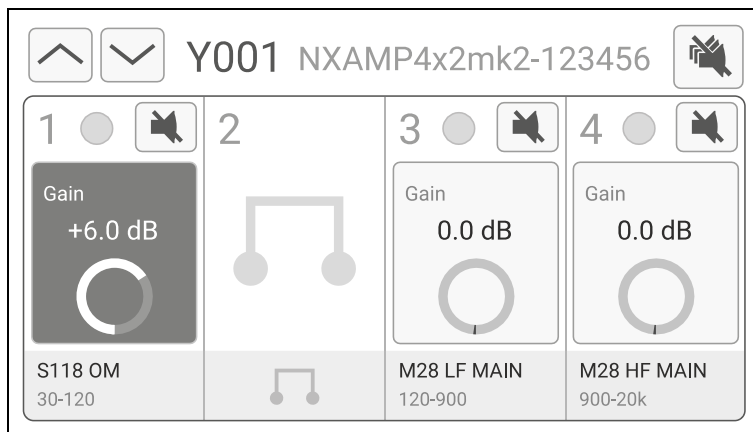

Select a channel (button is highlighted), then turn the wheel to change the gain setting.

You can select multiple channels, when a selected channel reaches the maximum value, it will cease to increase by continuing to turn the wheel, but other selected channels may still increase the setting; Be careful not to change a gap between two channel settings when selecting multiple channels at the same time.

In some special circumstances (cardioids setups for example) it is mandatory to have same gain settings on two or more channels. Then changing the gain on one of these channels will automatically adjust the gains on the other channels.

NB: You can adjust larger differences of gain between channels with the volume menu. There is no difference between gain and volume setting; this distinction is only done by analogy with traditional amplifiers. The CPU will always check gain, volume, patch, and headroom settings and decide what the best combination is between analog or digital gain to optimize the dynamic range of the system.

ARRAY-EQS

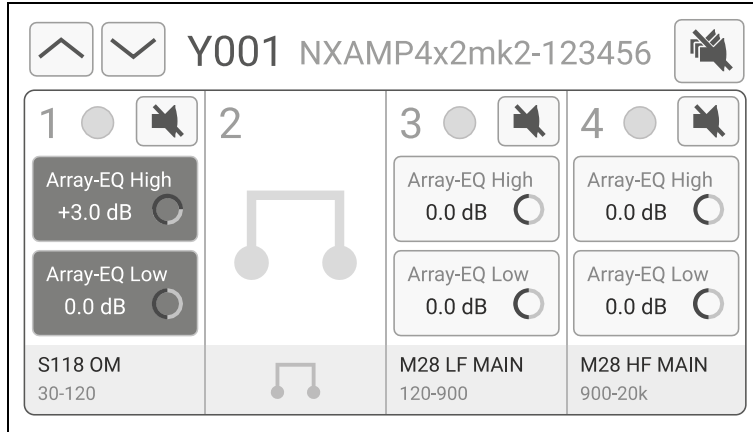

Select an Array-EQ in a channel (button is highlighted), then turn the wheel to change the Array-EQ setting. You can select multiple channels, when a selected channel reaches the maximum value, it will cease to increase by continuing to turn the wheel, but other selected channels may still increase the setting; Be careful not to change a gap between two channel settings when selecting multiple channels at the same time.

In some special circumstances (cardioids setups for example) it is mandatory to have same Array-EQ settings on two or more channels. Then changing the Array-EQ on one of these channels will automatically adjust the Array-EQs on the other channels.

EQ

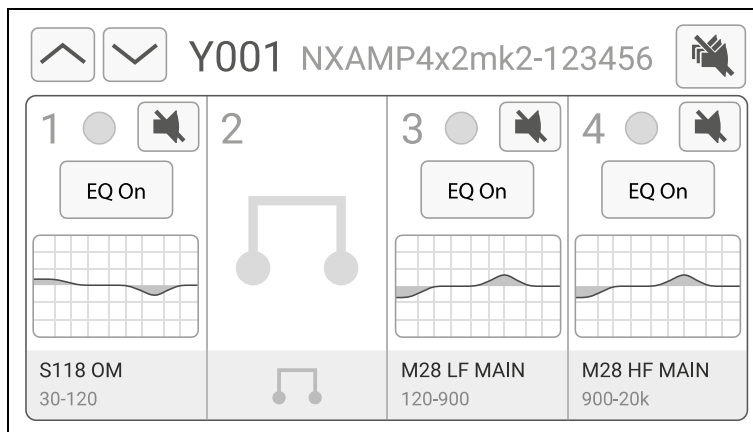

Press on any of the EQ thumbnail in a channel to adjust the 8-band full parametric EQ filters parameters. You can press several preview curves in a short time to edit multiple channels at once. On the displayed EQ View, press [+] to add a new EQ band. Pressing on one of the EQ points directly from the graph will show the following menu:

SETTINGS MENU

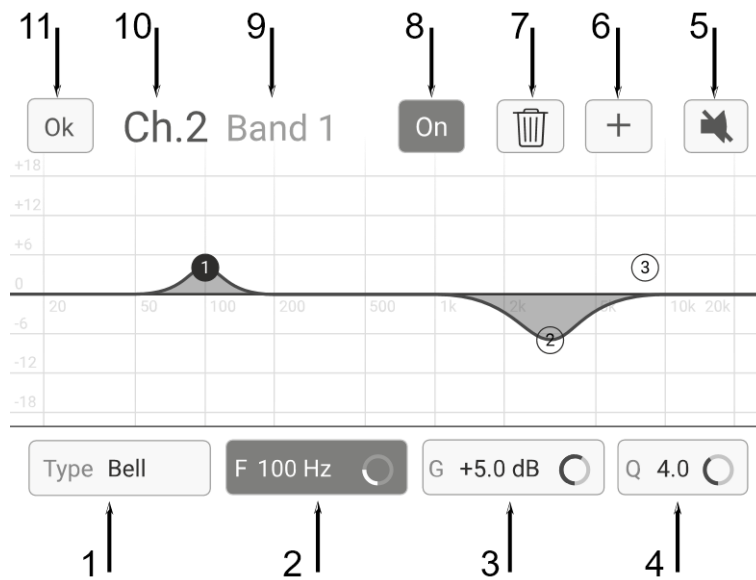

1: Type of filter, to select between Bell (Parametric), HighPass (2nd Order), LowPass (2nd Order), HighShelf (with adjustable Q), LowShelf (with adjustable Q) or Notch.

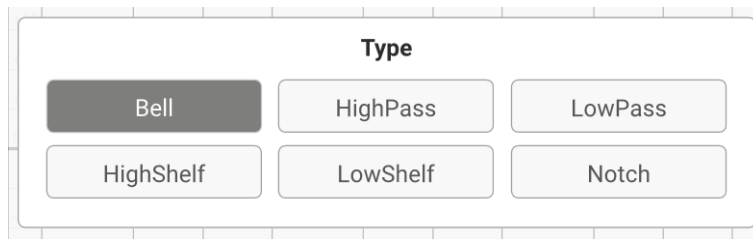

2: Frequency adjustment, to select among the 120 center frequencies available for each filter from 20 Hz to 20 kHz.

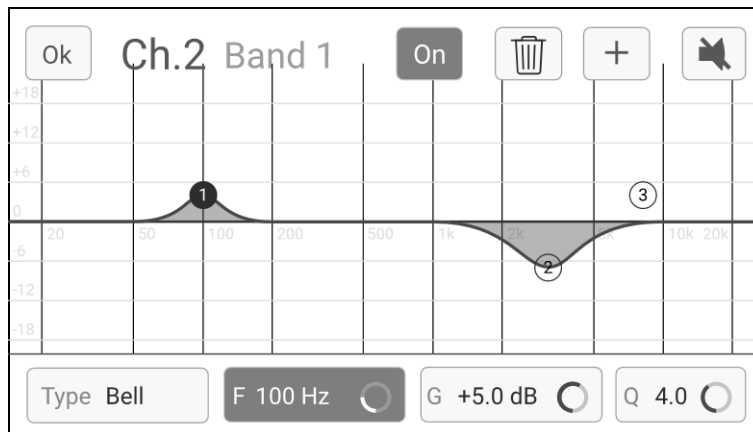

3: Gain adjustment, for filter type with gain settings the gain can be adjusted between -18 dB and +18 dB.

SETTINGS MENU

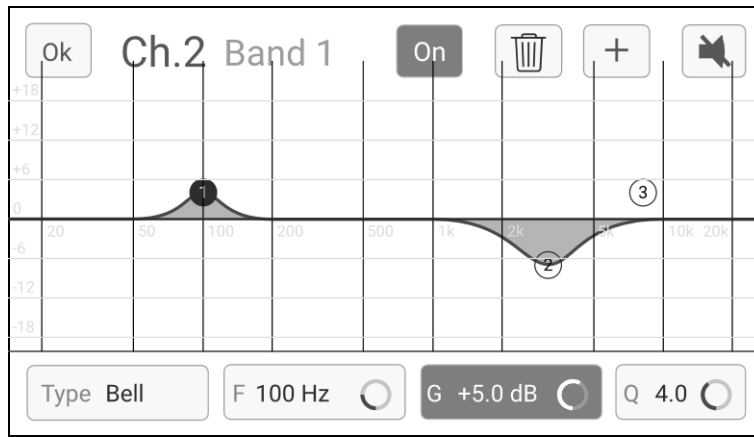

4: Q Factor adjustment, to select among the 40 steps available for each filter from 0.1 to 10.

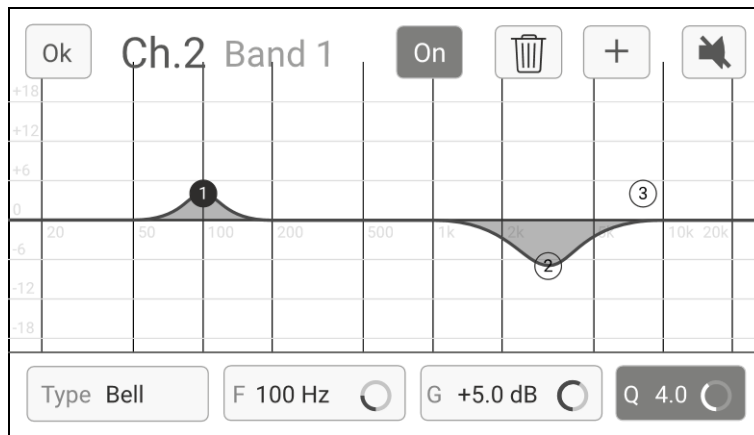

Select 2,3 or 4 and adjust the value with the wheel.

5: Mute, to mute the edited channel

6: Add an EQ point. Up to 8 EQ point can be set for each channel.

7: Delete an EQ point.

8: EQ point ON/OFF. The other EQ Points remain active. A Global ON/OFF is available on the main EQ page.

9: EQ point number currently in edition.

10: Channel(s) currently being edited. If several channels are selected, you will be prompted to flatten the EQ in case of different EQs.

11: OK, back to the selected channels EQ global functions as described below.

HEADER MENU

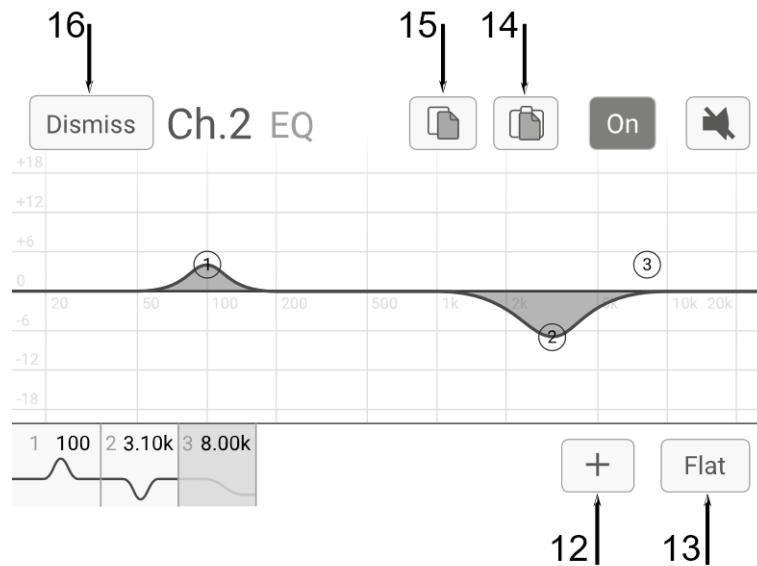

12: Add a new EQ point and enters the EQ point menu described above.

13: Flat, go back to a flat EQ curve.

14: Paste the EQ curve previously copied from another channel. You can paste on several channels at a time.

15: Copy the EQ from a specific channel or group of channels with similar EQ.

16: Return to the previous page

USING THE AMPLIFIER WITHOUT THE TDCONTROLLER FUNCTIONALITY

If you want to use the amplifier without the TDController, just choose the "FLAT" setup. In this mode no factory EQ and no speaker protection is applied to the cabinets.

In "FLAT mode", full amplifier digital protections are still available, and some functionality like volume control, input patching, mute, delay, gain, ArrayEQ and User EQ are working. Remote can be used as well.

HEADER MENU

This section describes the Header Menu and the settings you can adjust there.

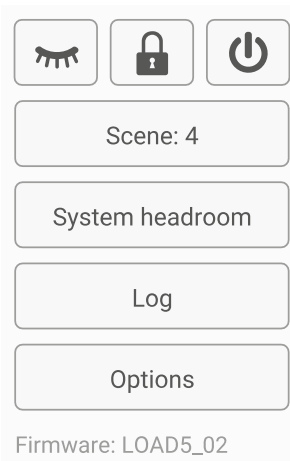

SCENE

On the above picture you can see “Scene” followed by scene number. You can save or recall a user scene (32 slots available). A scene is a copy of all NXAMPmk2 audio parameters, like a snapshot. However other parameters like network settings or user interface preferences are not part of a Scene.

TO SAVE A SCENE:

Prepare your parameters (in this example IDS110 for channels 1 & 3, ID24 90x40 for channels 2 & 4):

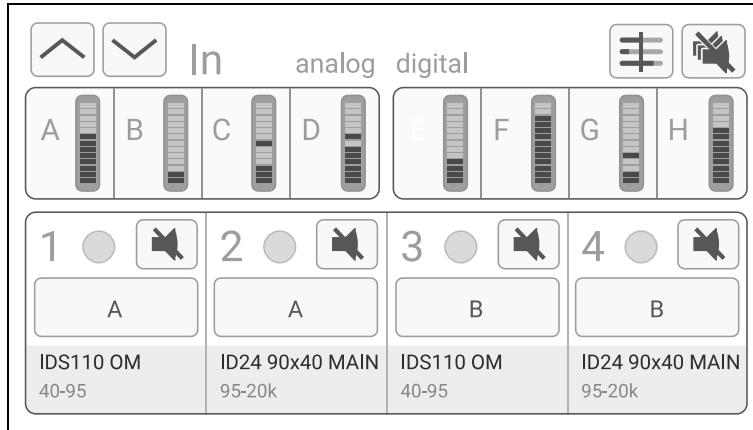

Then, push on the encoder and select scene Menu, select an empty slot:

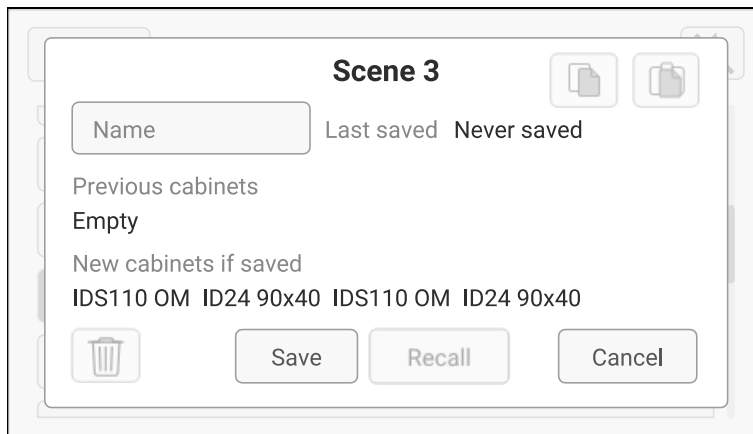

Enter the name of your user scene (10 characters max), then OK and Save.

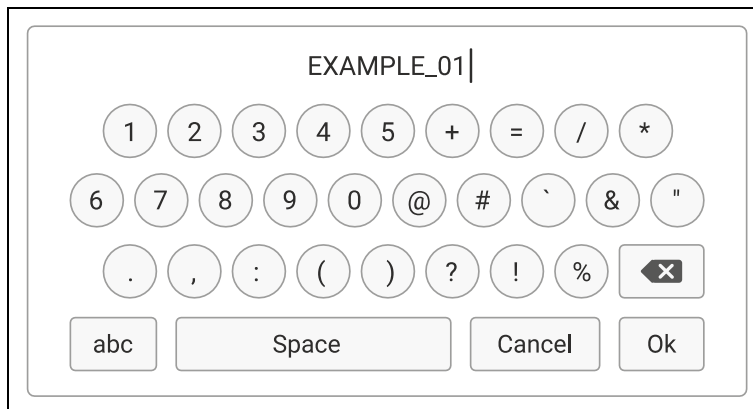

HEADER MENU

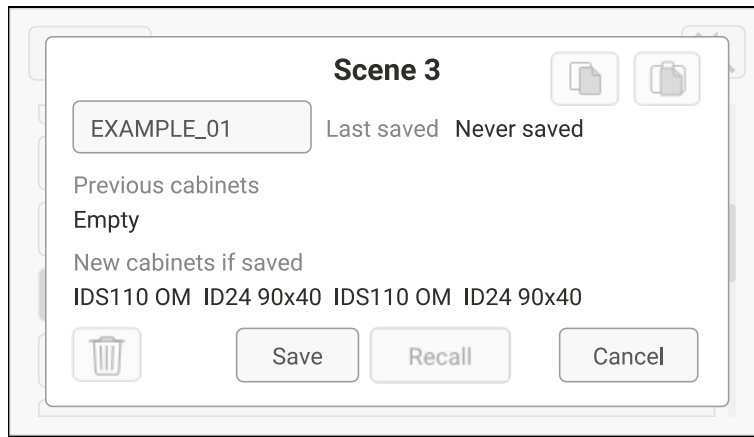

TO RECALL A SCENE

Select "Scene" in Header menu: Choose one of the user scenes (Theatre B for example), press Recall and Confirm.

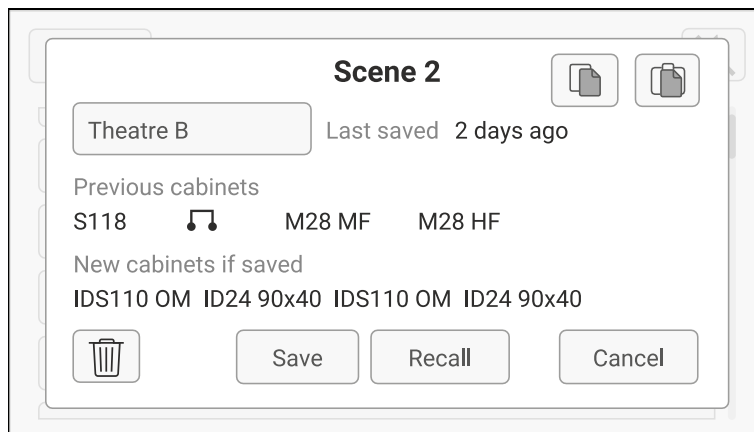
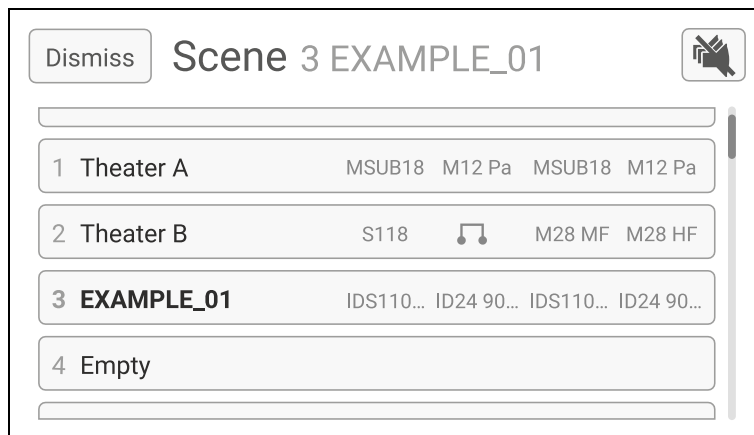

SYSTEM HEADROOM

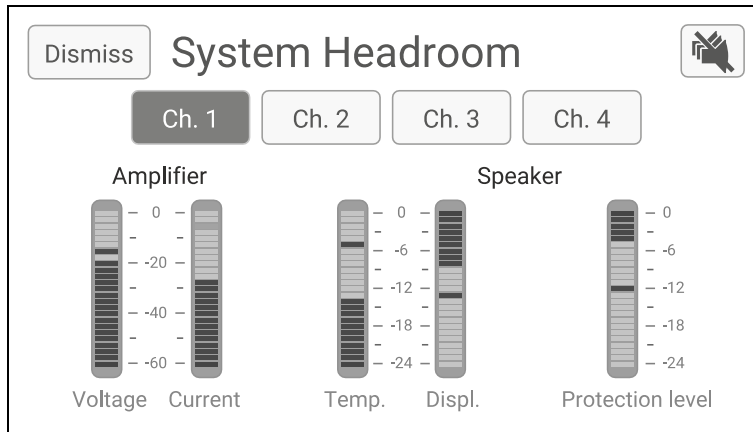

The System Headroom menu displays for each channel (selected by the top buttons Ch.1 to Ch.4) the headroom available from both the amplifier channel and the speakers connected to it.

On the amplifier headroom monitoring part, two vu-meters with a 60 dB scale are displaying the Output Voltage and the Output Current, both referring to 0 dB being the maximum voltage of the maximum current the amplifier can output. Please note that these maximum values are dependent on the NXAMPmk2 model.

On the speaker headroom monitoring part, three view meters with a 24 dB scale are displaying the temperature of the voice coils of the connected speakers, the displacement of the membranes, both referring to 0 dB being the maximum temperature and the maximum displacement the speakers can safely reach. Please not that these maximum values are dependent on the speaker’s preset used.

The last view meter is showing how much the NXAMPmk2 is reducing the output level to protect the speakers. This is a global meter displaying the maximum of all protections applied to the speaker, being a frequency selective displacement protection using a VCEQ (Voltage Controlled EQ), a wideband thermal protection for LF or HF driver for example, a peak limiter protection etc.

LOG

In this menu, you’ll find parameters and alerts from the NXAMPmk2 usage recorded over a long period of time.

The screenshot shows the 'Log' interface. At the top, there is a 'Dismiss' button, the title 'Log', a button for 'Avg. on 1 week', a 'Reset Min Max' button, and a hand icon. Below the title are navigation buttons '<' and '>', and the text 'Global'. The main part of the interface is a table with the following data:

	Min	Avg.	Max	Instant
Mains1 Voltage (V)	0	0	0	0
Power Supply1 Voltage(V)	0	0	0	0
Analogue Input Level A	-60dB	-60dB	-60dB	-60dB
Analogue Input Level B	-60dB	-60dB	-60dB	-60dB

You can select an averaging time (5 min to 1 day) for the measurements and reset the Log File.

HEADER MENU

Average Values

1 week	2 days	1 day
10 hours	5 hours	2 hours
1 hour	30 min	15 min
10 min	5 min	

 **Confirm Reset?**

You are about to reset min/max values, whereas log data is kept.

GLOBAL

The global parameters that can be logged are the followings.

- MAINS1 and MAINS2 (NXAMP4x4mk2 only) Voltage.
- Power Supply1 and Power Supply 2 (NXAMP4x4mk2 only) Voltage.
- Analogue Input Level A, B, C or D.
- Digital Input Level E, F, G or H.
- Overmute.
- Amp Protection by Limiting or Muting Outputs.

PER CHANNEL

- Power Amp Temp.
- Output Voltage and Current.
- Sense, Protection and Clip limiter action.
- Channel Mute.
- Speaker temperature, displacement, and protection.

Detail of these parameters can be found in [Log and Alert Parameters](#).

OPTIONS

The Option menu, accessible from the Header Menu, gives access to a large range of settings for many of the NXAMPmk2 parameters. This section describes each available sub-menu.

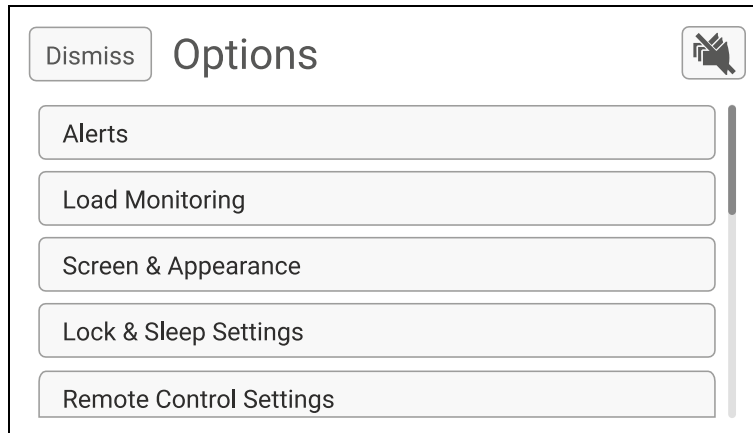

ALERTS

On this screen are displayed all the data stored about Errors, Alarms, Warnings (see APPENDIX).

- Amp protects
- Fans stopped
- Limiting output
- Muting output
- Channel Mains error / Power Supply / DC out / Overtemp / High Load / Low load
- Card Overclocking / Not ready / Audio err
- Analog fallback

LOAD MONITORING

The NXAMPmk2 Load Monitoring is an impedance monitoring function, measuring in real-time the impedance on the amplifier output channel. This allows to report (through its GPIO port or network) whether the speakers are correctly connected to the amplifier and ready to use. This function can be enabled and configured on every channel.

This is particularly useful for safety installations where the status of connected speakers should always be known, and any fault in the audio chain should be reported.

OPTIONS

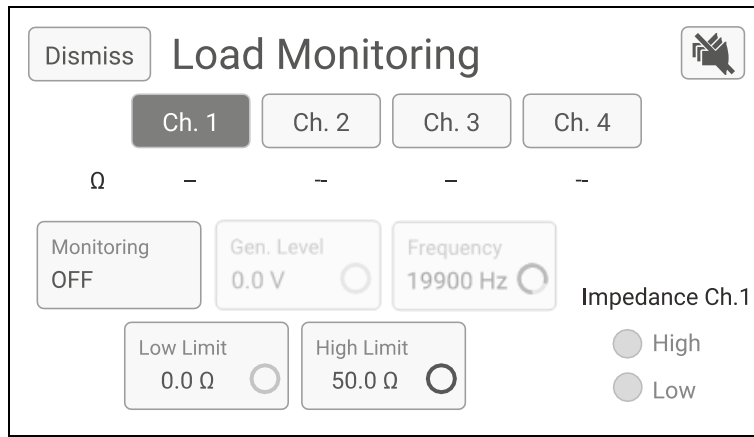

This menu allows setting up all the NXAMPmk2 Load Monitoring parameters per channel. Basically, this monitoring function measures the impedance on the amplifier channel at one frequency point and can report 2 alerts (“High” or “Low” impedance) if the measured impedance is out of the given low/high user-defined range.

Here are the parameters that can be configured:

MONITORING MODE

Here can be modified the Load Monitoring mode. 3 modes are available.

- **OFF:** The Load Monitoring is turned off. The impedance is not measured, no alerts are raised.

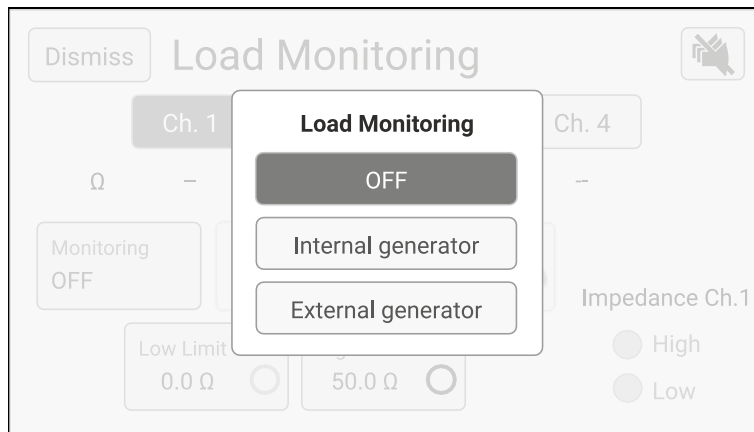

- **Internal Generator:** The Load Monitoring uses an internal HF burst generator and this signal is used to measure the impedance of the connected speakers.

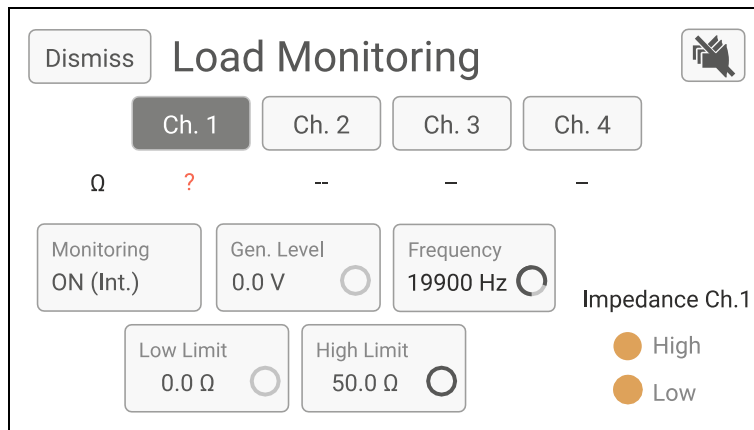

- External generator: The Load Monitoring uses an external HF pilot tone (sent to the NXAMPmk2 with the audio program) and this signal is used to measure the impedance of the connected speakers.

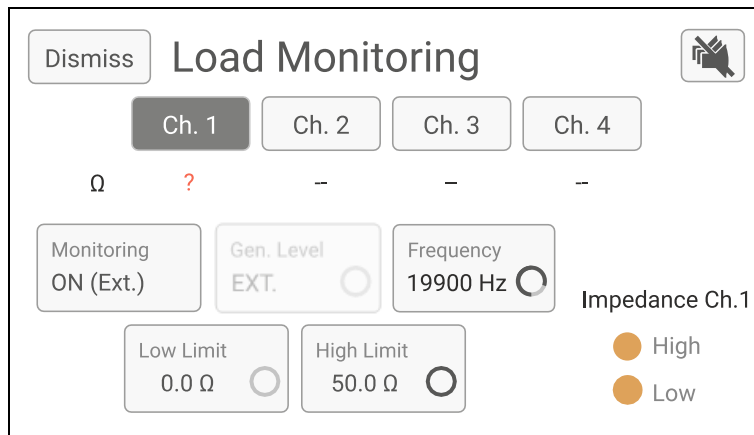

FREQUENCY

Here can be adjusted the frequency at which the impedance measurement will be done for the speaker(s) connected to the channel selected. The frequency is adjustable from 14500 to 21000 Hz in 1/12 octave steps.

Most of the time, there is no need to change this frequency if you are using the Internal Generator.

If external pilot tone is used (from the audio program sent to the NXAMPmk2 on its analog or digital inputs), be sure that the frequency selected here is close as possible to the pilot tone frequency.

LEVEL

The level of the internal HF burst generator can be adjusted here when using the Internal Generator mode.

The level is adjustable from 0 to 5 volts, with 0.5 volts steps. This voltage is intended to be given at the output of the NXAMPmk2 speakON connectors for the channel selected.

NB: Setting the level to 1 volt is a good start, then adjust the output level to have a stable reading of the impedance on the screen. Long speaker cable and high impedance speaker(s) connected might need a higher output voltage. An output voltage too high can lead to sub-harmonic generation that can be audible at the speaker output.

IMPEDANCE HIGH AND LOW LIMITS

Once the measured impedance is displayed on the screen, you can select low and high limits that will trigger the alerts “High” or “Low” impedance. These two alerts can be monitored directly through network or via the GPIO port (see GPIO section, to route them to GPIO pins).

NB: These limits should be adjusted with care. External parameters such as cable type and length, temperature, wind and output level can slightly change the speaker’s impedance measurement. Be sure to adjust these limits on site in real-life conditions to prevent false triggering of the impedance fault.

MEASURED IMPEDANCE

If the impedance of the connected load is between 0 and 100 Ohm at the measurement frequency, the actual value of the impedance will be displayed, for example “Z=17.3Ω”.

If the NXAMPmk2 is unable to measure the impedance of the speaker because there is no pilot tone (Internal generator at 0V or external pilot tone not detected), “Z=??Ω” will be displayed, and both “High” and “Low” impedance alerts will be raised.

SCREEN & APPEARANCE

Allows you to customize the screen (background image, tint colour and luminosity).

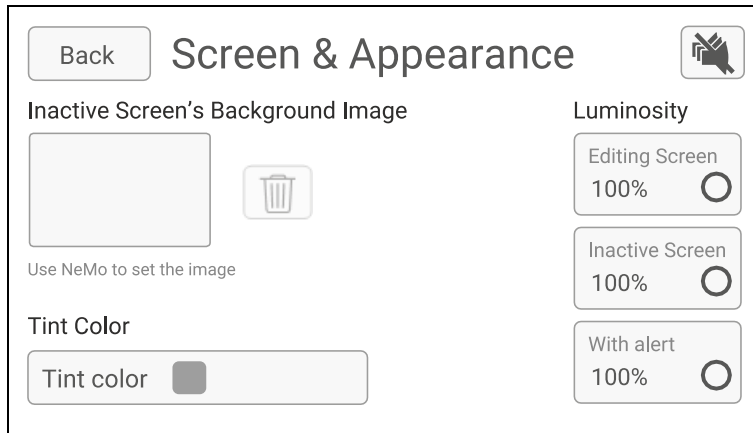

The Inactive Screen background image can be set using NEXO NeMo. Please refer to NEXO NeMo's user guide for more information.

However, it is still possible to delete an image set by NeMo from this menu. Then, the Inactive View background is the simply the tint colour.

LOCK AND SLEEP SETTINGS

Allows you to Lock the device with a password, manage the screen saver.

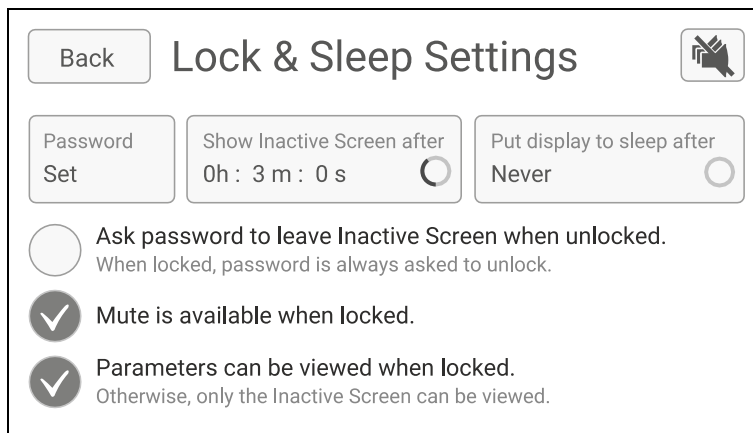

Password is used to lock:

- The screen,
- The remote-control access (NEXO NeMo and third-party controllers),
- The firmware update (NEXO NeFu).

Password can be left empty.

REMOTE CONTROL SETTINGS

IMPORTANT NOTE

All network settings available in this page are for the NXAMPmk2 amplifier itself.

OPTIONS

Since the introduction of the NXDT104mk2 (Dante™) and NXAE104 (AES/EBU), a network switch is included on the extension card connecting the amplifier directly to the network. So, with any of these 2 cards, the card has an IP address and the NXAMPmk2 has also an IP address.

For example, with NXDT104mk2 card, the IP address on Dante™ Controller is the card IP address (used for audio network), and the IP on NeMo is the amplifier IP address (used for remote-control).

DEVICE ID

Here can be modified the NXAMPmk2 Device ID.

The Device ID is composed of one 'Y' letter followed by 3 characters, with each character between 0 and 9 (for digits) or between A and F (for letters), so for example "Y014".

The Device ID is always included in front of the Dante™ card name on the Dante™ network. On the following [Dante™ Controller screenshot](#), we can see that the Dante™ card name is "Y014-NEXO-NXAMP4x4mk2-062c60".

The Device ID can be edited on Dante™ Controller by editing it directly in the Dante™ card name.

NAME

Here can be modified the NXAMPmk2 name, used and displayed by the remote-control software (NEXO NeMo).

NB: The NXAMPmk2 name is not the same than the Dante™ card name, but a function is available in NeMo to sync them on request (see NeMo user guide).

MODE

Here can be modified the NXAMPmk2 IP mode. 2 modes are available: "Static" or "DHCP/AutoIP".

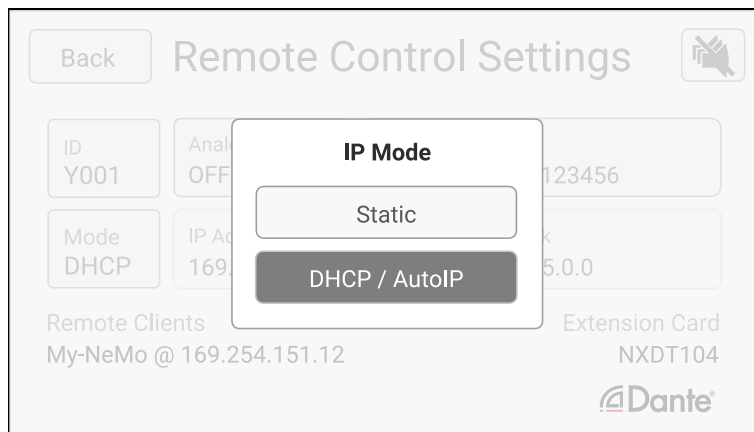

- "DHCP/AutoIP" mode is the default one and the recommended one to get the network working easily. When the amplifier starts, it asks an IP address on the network using a DHCP request. If no DHCP server answers by giving an address, the amplifier switches automatically in Auto-Addressing mode and takes an IP address in the auto-assign form "169.254.xxx.xxx".

The screenshot shows the 'Remote Control Settings' interface. At the top left is a 'Back' button, and at the top right is a hand icon. The settings are as follows:

- ID: Y001
- Analog Fallback: OFF
- Name: NXAMP4x2mk2123456
- Mode: DHCP
- IP Address: 169.254.6.4
- Netmask: 255.255.0.0
- Remote Clients: My-NeMo @ 169.254.151.12
- Extension Card: NXDT104

A 'Renew' button is located between the IP Address and Netmask fields. The Dante logo is at the bottom right.

- “Static” mode allows the user to use a fixed IP address and netmask for the amplifier. This mode can be used in some cases when the NXAMPmk2 needs to be included in a wider existing network with a strict structure already established (on fixed installations for example).

The screenshot shows the 'Remote Control Settings' interface with the Mode set to Static. The settings are as follows:

- ID: Y001
- Analog Fallback: OFF
- Name: NXAMP4x2mk2123456
- Mode: Static
- IP Address: 192.168.1.100
- Netmask: 255.255.0.0
- Remote Clients: My-NeMo @ 192.168.1.102
- Extension Card: NXDT104

The Dante logo is at the bottom right.

IP ADDRESS / NETMASK:

Here can be modified the IP address and the Netmask if using the “Static” mode. If using the “DHCP/AutoIP” mode, the IP address and the Netmask are displayed but are not editable.

When using the “DHCP/AutoIP” mode, a “renew” button is available to clear the IP address, and ask a new one on the network. It can be useful if a DHCP server has been connected by mistake on the network, to restart the addressing process and switch back to Auto-Addressing.

ANALOG FALLBACK:

Analog Fallback is intended to provide analog audio redundancy of the digital audio inputs. It works with both NXDT104mk2 (Dante™) and NXAE104 (AES/EBU).

Analog Fallback (and digital audio) still works on NXAMPmk2 with NXDT104 (Dante™) and NXES104 (Ethersound™), even if remote control is reduced to NXAMPmk1 controllable parameters set (cannot control new mk2 functions).

⚠ WARNING!

NXDT104mk2 & NXDT104 should run with firmware 1C02 or above to provide this functionality.

This function works by muting the analog inputs while the audio network is OK (see below for details). If the audio network fails, the analog inputs are automatically unmuted. If the audio network comes back, then the analog inputs are muted again.

NB: All analog and digital inputs are still available for NXAMPmk2 patching when Analog Fallback is used. But analog inputs will be muted if audio network is running.

If the Analog fallback mode is ON, and the audio from Network (Dante™, AES/EBU or Ethersound™) is missing, the NXAMPmk2 will display the following message:

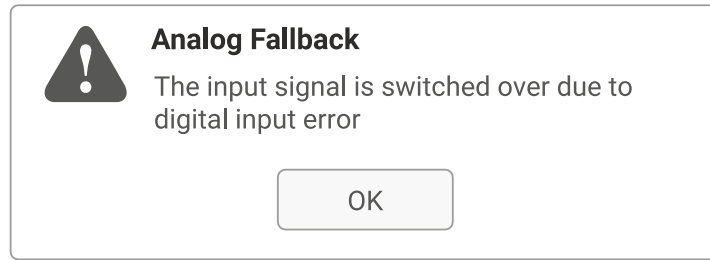

- When used with NXDT104mk2. Detection of a valid audio network when using NXDT104mk2 is based on audio subscription. It means that the NXDT104mk2 is checking if audio packets from the Dante™ Transmitter(s) are received correctly. If the network fails somewhere (cable removed, transmitter switched off or excessive packet loss), the analog inputs will be unmuted, even if the NXAMPmk2 is still connected to the network and the remote control is still working.

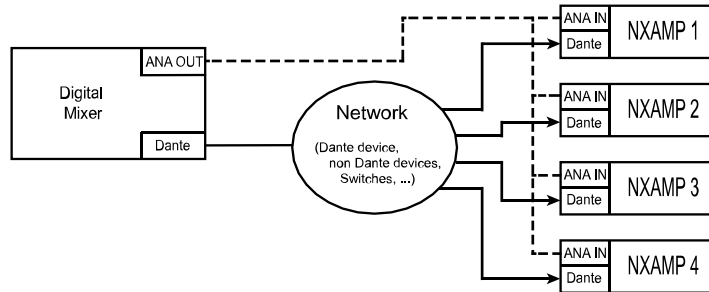

If for example, the NXAMPmk2 n°2 does not received the audio packets from the subscribed source (here the mixer) then it will unmute the analog inputs, as shown below.

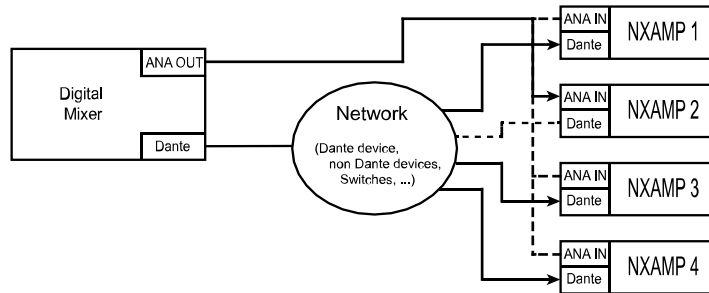

The name of the subscribed transmitter(s) can be checked into the Dante™ Controller, on “Device View. On the below picture, we can see for example that the NXAMPmk2 with the Dante™ card name “Y014-NEXO-NXAMP4x4mk2-062c60” has subscribed to channel 01, 02, 03 and 04 from the Dante™ device named “NEXO-PC” (a computer running the Dante™ Virtual Soundcard software).

NB: The NXDT104mk2 can subscribe up to four different channels from four different Dante™ transmitters.

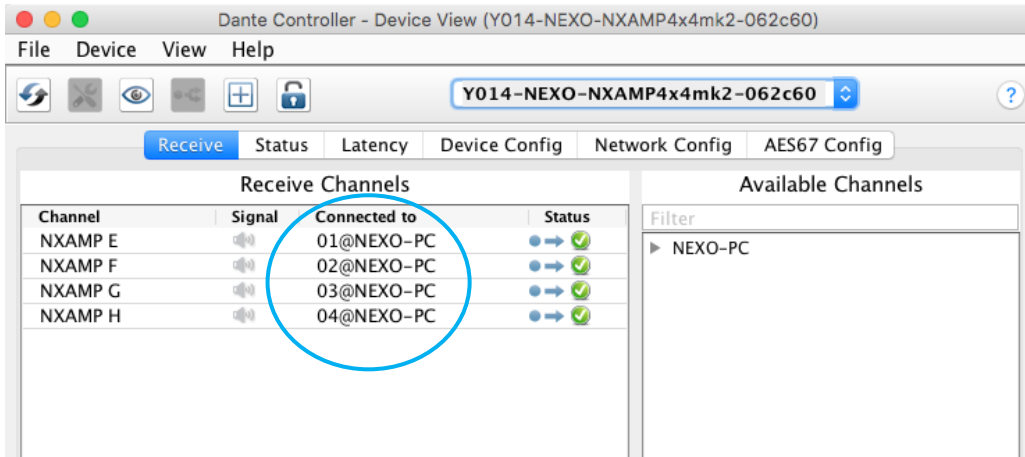

The digital audio status for the NXAMPmk2 is declared OK if all digital input channels E/F/G/H are declared OK, otherwise all analog inputs are un-muted.

A digital input itself is declared OK if connected to nothing (aka. not patched) or patched with a subscription and an audio stream valid, otherwise if the stream is failing or the subscription is unresolved the input is declared faulty.

- When used with NXAE104. Detection of a valid digital audio stream on AES/EBU is based on the clock locking information. If there is digital signal on the AES/EBU input, and the clock detected is within the accepted clock range, the receiver clocks itself on the signal and the receiver is said "LOCKED".

The digital audio status for the NXAMPmk2 is declared OK if all digital input channels E/F (XLR1) and G/H (XLR2) are declared OK, else all analog inputs are un-muted.

A digital input itself (E/F or G/H) is declared OK if there is signal and the receiver is "LOCKED". So, if you are using E/F inputs only and the Analog Fallback, please link E/F input to G/H input with a small XLR cable.

- When used with NXES104. The Ethersound™ network should be in star configuration for the Analog Fallback to work properly. It does not work in daisy chain configuration (except for simple network like one mixer to one receiver). It does not work with ASIO input either.

The detection is based on a valid Ethersound™ stream on the IN port of the NXES104. If a valid Ethersound™ stream is detected, the analog inputs will be muted, else they will be unmuted.

GROUPS AND ZONES:

This page displays the groups and zones the NXAMPmk2 and its channels belong to.

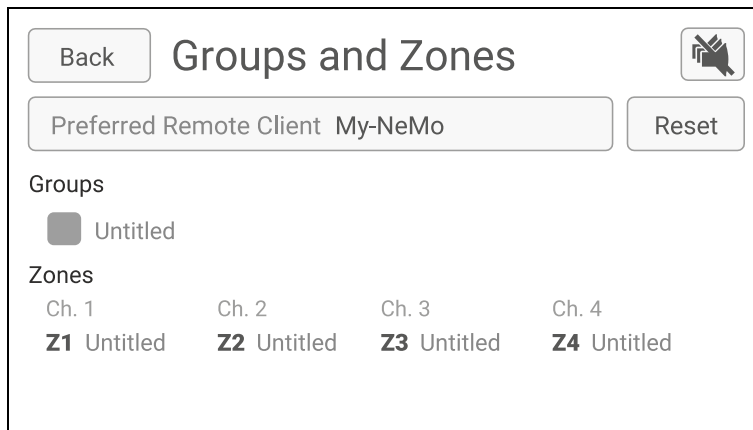

OPTIONS

From the remote-control software NEXO NeMo, it is possible to create groups of devices and zones of channels. They are saved in a document called session. When a session is online, the NXAMPmk2s are aware of the groups and zones they belong to.

Because there can be up to two remote clients (instances of NeMo) connected at the same time to an NXAMPmk2, with two different sessions, the NXAMPmk2 must be able to choose between the two.

Preferred Remote Client: the remote client (an instance of NeMo) from which groups and zones are taken. When this client updates the groups and/or zones, the changes are automatically reflected on this page.

Groups and zones are persistent even after the remote client is disconnected. They are then updated next time this client is connected.

By setting another Preferred Remote Client, groups and zones are then taken from the other client.

If no Preferred Remote Client has been manually set (default), the groups and zones are taken from the latest connected remote client. They are still automatically updated and preserved after the last remote client is disconnected.

The groups and zones are displayed for informational purposes, as well as to provide a way to quickly identify the devices: the tint colour of the screen can depend on the group the NXAMPmk2 belongs to. To do so:

Go to Options > Screen Appearance > Tint Colour and check Tint Colour Depends on Groups.

The tint colour becomes the colour of the last group this NXAMPmk2 belongs to in the session of the latest/preferred remote client. It is automatically updated when groups change.

GPIO SETUP

The GPIO (Global Purpose Input/Output) port is foreseen to easily interconnect the NXAMPmk2 with other units (remote control or monitoring units for example) without remote control software to develop. Many functions can be affected to each input or output pin of this port, or a global usage of all the pins can be affected.

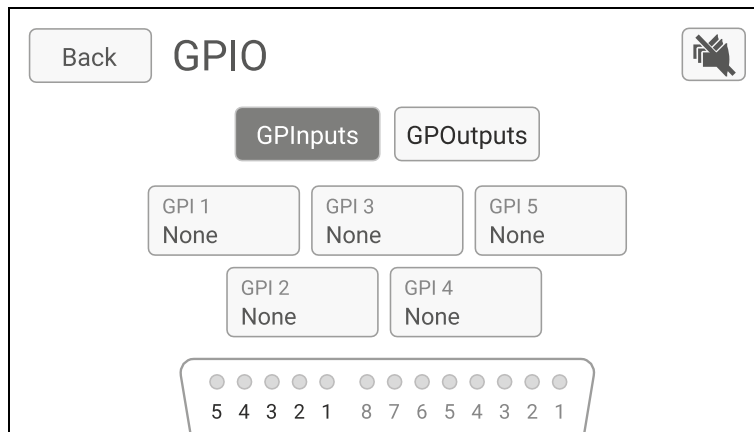

The five LEDs to the left at the bottom of the screen are real-time monitoring the values of the input pins of the NXAMPmk2's GPIO port (Gray means low, Green means high, i.e. +5V).

The eight LEDs to the right are real-time monitoring the values of the output pins.

LEDs are in reverse order, as are the pins on the GPIO port (DB-25 connector).

GPIO CONFIGURATION

To select the GPIO configuration mode, press the top-right button:

- DMU: GPIO port is connected to DMU for metering purposes.
- Custom: GPIO port is used for custom control and monitoring. The functions associated to its pins can be individually configured.

INPUT PINS CONFIGURATION

In Custom Mode, to configure the input pins (control functions), press GPIInputs. Input pins are numbered from GPI 1 to GPI 5.

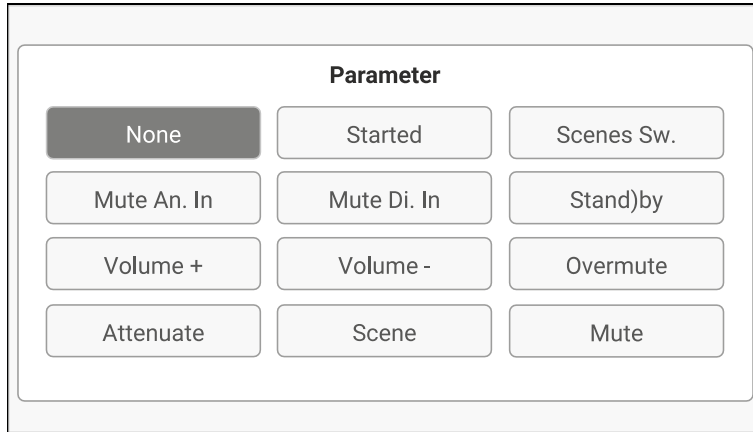

Then choose a parameter (see table below, e.g. Switch Scene), then if needed a first and a second option (e.g. the Scenes to switch). Finally, choose if this action should be triggered when the pin's state is high, low, or on impulse (there is no threshold).

Note that an action based on a permanent state (e.g. Stand-by) is only validated after the pin's state has changed and is stable during 1 second.

In case there is competition between input functions (e.g. GPI1 is mute ON and GPI3 is mute OFF), note that treatment is sequential (in this example, mute OFF wins).

Name	Short Name	Options	Possible States			Description
			Low	High	Imp.	
Power amp start	Started		X			NXAMP will wait till pin goes to the chosen state to start the amplifier part (big power supplies). Then the pin stays at the chosen state, so several amps. can be linked together.
Switch scene	Scenes Sw.	Scenes A and B	X	X	X	Recalls a scene or another, or toggle between two scenes. If "Active on High": scene A is recalled when GPI is low, and scene B is recalled when GPI is high. If "Active on Low", it is the opposite.
Analog inputs Mute	Mute An. In		X	X	X	Mutes or unmutes the analog inputs.
Digital Inputs Mute	Mute Di. In		X	X	X	Mutes or unmutes the digital inputs.
Stand-by	Stand-by		X	X	X	Put the NXAMP in stand-by mode or back to the running mode. In case of Impulse mode, the action is triggered only after 3 seconds.
Volume Increase	Volume +				X	Relatively increases the volume of all the channels, see documentation for the steps. Even if max volume is reached on a channel, continues incrementing volume on other channels. And when start decreasing, the value differences between the channels are restored.
Volume Decrease	Volume -				X	Relatively decreases the volume of all the channels, see documentation for the steps. Even if min volume is reached on a channel, continues decrementing volume on other channels. And when start increasing, the value differences between the channels are restored.
Overmute	Overmute		X	X	X	Mutes or unmutes all the output channels.
Attenuate	Attenuate		X	X	X	Attenuates of 20dB or not all the output channels.

OPTIONS

Scene Recall	Scene i	Scene			X	Recalls a scene. It is possible to assign this function to several pins to be able to switch between several scenes.
Channel mute	Mute i	Channel	X	X	X	Mutes or unmutes one channel.

OUTPUT PINS CONFIGURATION

In Custom Mode, to configure the output pins (monitoring functions), press GPOutputs. Outputs pins are numbered from GPO 1 to GPO 8. To configure an output pin, follow the same steps as above for the input pins.

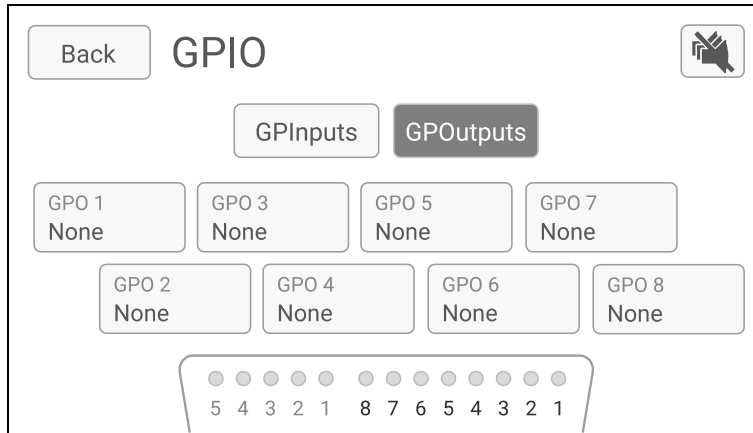

Name	Short Name	Options	Possible States			Description
			Low	High	Imp.	
Power amp starting status	Started		X			Power amp is started.
Scene recall status	Scene i	Scene	X	X		Scene parameter 1 is recalled for the chosen polarity.
Analog inputs mute status	An. In Mute		X	X		Analog inputs are mute (does not apply to Analog Fallback Mode ON and input channels muted).
Digital inputs mute status	Di. In Mute		X	X		Digital inputs are mute
Stand-by status	Stand-by		X	X		Stand-by mode is ON.
Running status for CP4SW	Running					High when stand-by mode is OFF. Blinking when stand-by.
Max volume status	Max Volume					High when maximum volume is reached on at least one channel. Blinking when an increase command is received.
Min volume status	Min Volume					High when minimum volume is reached on at least one channel. Blinking when a decrease command is received.
Mute status	All Mute		X	X		All channels are muted (overmute).
Attenuation status	All Atten.		X	X		All channels are attenuated.

OPTIONS

GPI follow-up	GPI i	GPI	X	X	Reflects or inverse the state of a GPIInput (with small delay and without glitch). Example of use: send to another amp the Impulsive recall scene.
Channel sense	Sense ch. i	Channel	X	X	Channel has output current. Reflects the signal LED.
Channel fault	Fault ch. i	Channel	X	X	Channel is not clipping and not protecting. Reflects the peak or protect LEDs.
Channel mute	Mute ch. i	Channel	X	X	Channel is muted.
Channel impedance status	Imped. ch.i	channel	X	X	Impedance of the channel is correct, i.e. there is no fault and NXAMP is able to measure the impedance, and the measured impedance is within the limits set on the Load Monitoring page.
All impedances status	All Imped.		X	X	Impedance is correct for all channels, i.e. no channel is reporting a fault, NXAMP is able to measure the impedance, and the measured impedance for all the channels is within the limits set on the Load Monitoring page.
All amplifiers status	Amp status		X	X	All channel amplifiers are ok, i.e. no channel is reporting a fault. It can be useful to monitor amplifier status when Load Monitoring is not used.

DEVICE INFORMATION

Displays some numeric information about the unit like Serial Number, Firmware, Main, Boot and Boot2 revision.

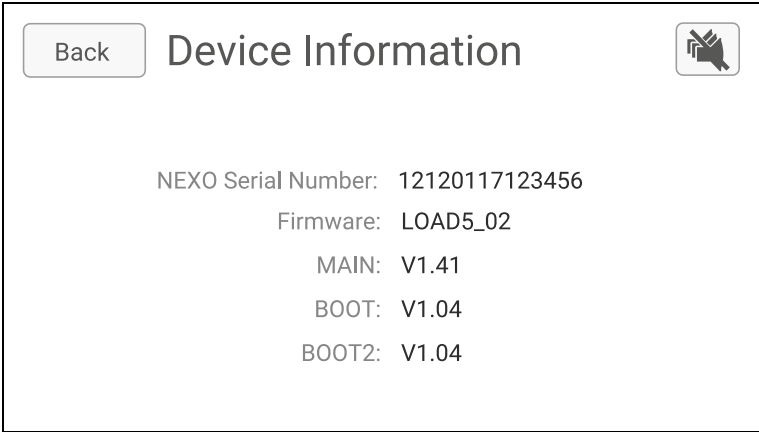

DELAY UNIT

You can select the unit for the delay, between millisecond, meter or feet.

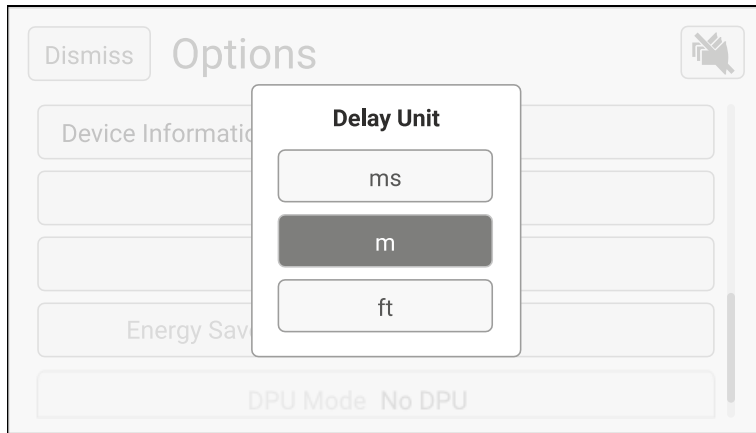

OUT MODE

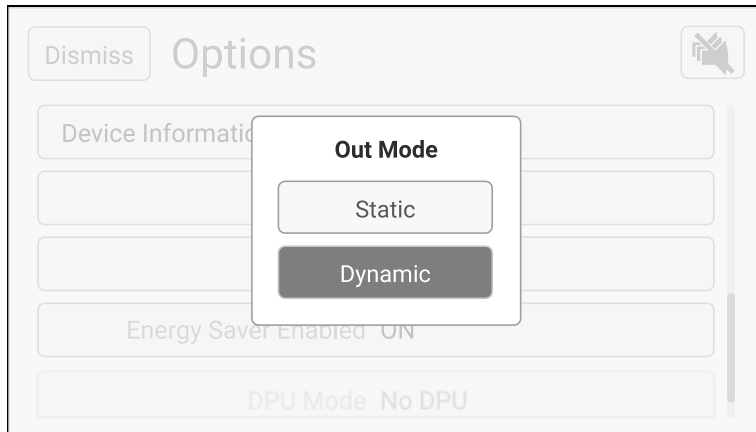

By default, output mode is set to “Dynamic” meaning that if two speakon with output on Speakon 4 poles, 2+/2- pins, are set up to adjacent Speakon, the controller will automatically cross the amplifier outputs to have the channel 1 outputting on Speakon A and Channel 2 outputting Speakon B and so on.

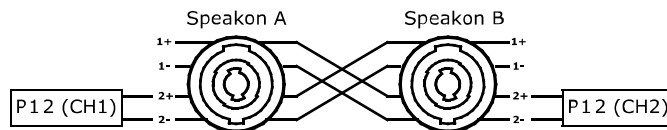

This could be a problem when using proprietary patch panel foreseen to be used with CH1 always outputting on Speakon A (1+/1-) and Speakon B (2+/2-). In this case, this menu enables to go back to “Static” mode.

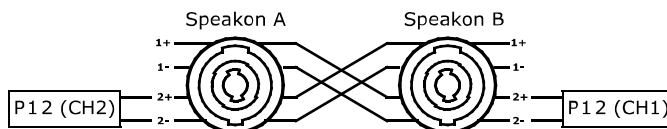

Note that if both adjacent speakers do not use output on 2+/2-, this setting has no influence, as output mode will always be like the “Static” one.

ENERGY SAVER ENABLED

When enabled, the amplifier goes to Energy Saver Mode when no input signal has been received during a given time interval. The power consumption is then reduced. When input signal is received again, the amplifier leaves the Energy Save Mode.

You can adjust the No-signal time interval from 1 minute to 3 hours.

You can adjust the No-signal threshold level from -70 dBFS to – 60 dBFS.

By default, Energy Saver Mode is disabled.

DPU MODE

See Chapter DPU Digital Patching Unit for NXAMP.

ALERTS LIST

GLOBAL

MAINS1 VOLTAGE(V)

The mains 1 voltage is out of the limits Over 276[V] (4x1/4x2) Under 60[V] or over 276[V] (4x4)	Automatically shut down and reboot. After reboot, Error Screen displayed until the causes are removed.	A. The connection between the power source and the amplifier might be wrong. B. Unstable power source.	Check AC power connection
---	--	---	---------------------------

MAINS2 VOLTAGE(V) – ONLY 4X4

The mains 2 voltage is out of the limits Under 60[V] or over 276[V]	Automatically shut down and reboot. After reboot, Error Screen displayed until the causes are removed.	A. The connection between the power source and the amplifier might be wrong. B. Unstable power source.	Check AC power connection
--	--	---	---------------------------

POWER SUPPLY1 VOLTAGE(V)

The output of the power supply is out of the limits	Automatically shut down and reboot. After reboot, Error Screen displayed until the causes are removed.	The power supply unit of the amplifier might malfunction due to some unexpected reason.	Call service center
---	--	---	---------------------

POWER SUPPLY2 VOLTAGE(V) – ONLY 4X4

The output of the power supply is out of the limits	Automatically shut down and reboot. After reboot, Error Screen displayed until the causes are removed.	The power supply unit of the amplifier might malfunction due to some unexpected reason.	Call service center
---	--	---	---------------------

ALERTS LIST

POWER SUPPLY1 OVERTEMPERATURE

Abnormal temperature has been detected by the temperature sensor on the heat sink of the power supply.	FAN starts rotation at max speed	A. Environmental temperature is too high B. Unexpectedly overloaded	Check the air flow
--	----------------------------------	--	--------------------

POWER SUPPLY2 OVERTEMPERATURE – ONLY 4X4

Abnormal temperature has been detected by the temperature sensor on the heat sink of the power supply.	FAN starts rotation at max speed	A. Environmental temperature is too high B. Unexpectedly overloaded	Check the air flow
--	----------------------------------	--	--------------------

AMPLIFIER MUTING OUTPUT

The output is muted to protect the amplifier	All channel Mute.	A. Environmental temperature is too high B. Unexpectedly overloaded	This alert is triggered only if the alert condition cannot be removed by other protections such as limiter, mute and fan rotation.
--	-------------------	--	--

FAN1 ERROR

Error detected on Fan 1	Number of malfunctioned fans: 1 of 3: Display alert message on GUI. 2 or more of 3: Automatically shut down and reboot. After reboot, Error Screen displayed until the causes are removed.	This alert is triggered when CPU cannot sense the fan's actual rotation speed, which implies: A. FAN might malfunction. B. FAN rotation sensing circuit might malfunction.	Call service center
-------------------------	--	--	---------------------

FAN2 ERROR

Error detected on Fan 2	Number of malfunctioned fans: 1 of 3: Display alert message on GUI. 2 or more of 3: Automatically shut down and reboot. After reboot, Error Screen displayed until the causes are removed.	This alert is triggered when CPU cannot sense the fan's actual rotation speed, which implies: A. FAN might malfunction. B. FAN rotation sensing circuit might malfunction.	Call service center
-------------------------	--	--	---------------------

ALERTS LIST

FAN3 ERROR

Error detected on Fan 3	Number of malfunctioned fans: 1 of 3: Display alert message on GUI. 2 or more of 3: Automatically shut down and reboot. After reboot, Error Screen displayed until the causes are removed.	This alert is triggered when CPU cannot sense the fan's actual rotation speed, which implies: A. FAN might malfunction. B. FAN rotation sensing circuit might malfunction.	Call service center
-------------------------	--	--	---------------------

ANALOG FALLBACK

The input signal is switched over due to digital input error		This alert is triggered when Analog Fallback logic is triggered.	Check the digital input connection or network settings.
--	--	--	---

MAINS NOT CONNECTED – ONLY 4X4

One of the two MAIN plugs is not connected to the power source.	Automatically shut down and reboot. After reboot, Error Screen displayed until the causes are removed.		Check AC power connection.
---	--	--	----------------------------

PER CHANNEL

POWER AMP DC OUTPUT ALERT

DC output is detected in the given amplifier channel	Automatically shut down and reboot. After reboot, Error Screen displayed until the causes are removed.	The amplifier unit might malfunction due to some unexpected reason.	Call service center
--	--	---	---------------------

AMPLIFIER OVERTEMPERATURE LEVEL1

Amplifier temperature reaches 65 degree: Output is reduced by 1dB (4x1/4x2) Amplifier temperature reaches 70 degree: Output is reduced by 1dB (4x4)	Per channel limit	A. Environmental temperature is too high B. Unexpectedly overloaded	Check the air flow
--	-------------------	--	--------------------

AMPLIFIER OVERTEMPERATURE LEVEL2

Amplifier temperature reaches 75 degree: Output is reduced by 3dB (4x1/4x2) Amplifier temperature reaches 80 degree: Output is reduced by 3dB (4x4)	Per channel limit	A. Environmental temperature is too high B. Unexpectedly overloaded	Check the air flow
--	-------------------	--	--------------------

AMPLIFIER OVERTEMPERATURE LEVEL3

Amplifier temperature reaches 80 degree: Output is muted (4x1/4x2) Amplifier temperature reaches 100 degree: Output is muted (4x4)	Per channel limit	A. Environmental temperature is too high B. Unexpectedly overloaded	Check the air flow
---	-------------------	--	--------------------

AMPLIFIER OVERCURRENT ALERT

Overcurrent is detected in the given amplifier channel	Per channel mute	The impedance of the connected speaker might be too low or shorten wrongly.	Please check the speaker connection.
--	------------------	---	--------------------------------------

HIGH LOAD ALERT

The measured impedance is over the predefined upper limit.	Behaves as defined in Load Monitoring function specification		
--	--	--	--

LOW LOAD ALERT

The measured impedance is under the predefined upper limit.	Behaves as defined in Load Monitoring function specification		
---	--	--	--

DPU DIGITAL PATCHING UNIT FOR NXAMP

The Digital Patching Unit (DPU) is a 1U 19" accessory for NXAMP and NXAMPmk2 powered TDControllers. This device is intended to automatically set up the power outputs of an NXAMP Powered TDController to the correct pins on speakON 4 and speakON 8 connectors. Thus, connecting any of the NEXO speakers is very straight forward. Moreover, it is easy to connect several DPU together in case multiple amplifiers are needed to feed a unique speaker system.

FRONT PANEL DESCRIPTION

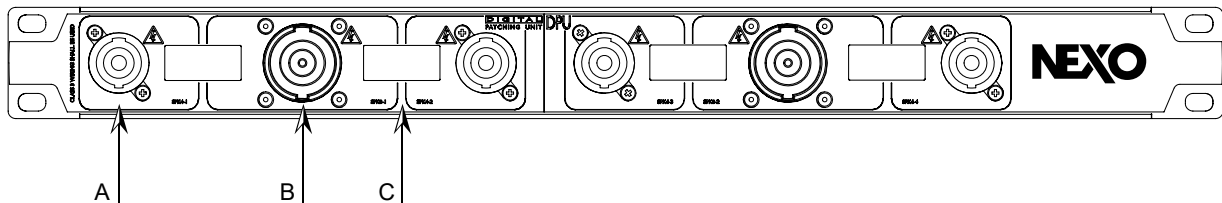

A: SPEAKON 4 POLES OUTPUT

There are four connectors like this on the front panel. These connectors will be used to connect any NEXO speaker that uses the same type of connector.

B: SPEAKON 8 POLES OUTPUT

There are two connectors like this on the front panel. These connectors will be used to connect the NEXO speaker of your choice, if it uses the same type of connector or it uses EP6 connector. The use of speakers with EP6 connectors means the use of external pin to pin adaptor from speakON 8 to Amphenol EP6 with the following arrangement.

SpeakON 8 input	EP6 output
1 -	1
1 +	2
2 -	3
2 +	4
3 -	5
3 +	6
4 -	NC
4 +	NC

C: LCD DISPLAY

There are four LCDs like this one on the DPU. These LCDs indicate which speaker should be connected on which output. See further in the manual to have the actual displayed information.

BACK PANEL DESCRIPTION

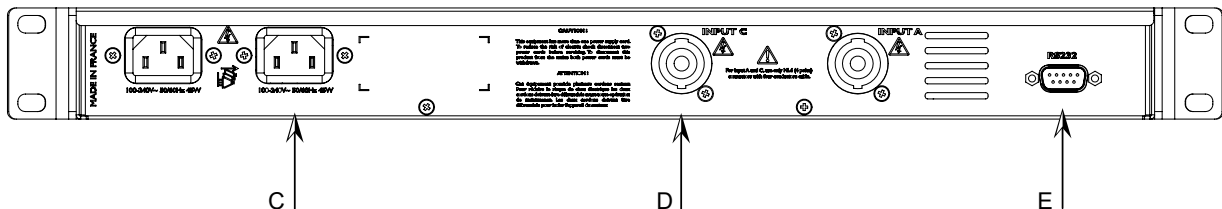

⚠ WARNING!

Unplug the device from mains before connecting or disconnecting any cable to or from it.

C: MAINS CONNECTORS

There are two mains connectors on the DPU. These two connectors lead to two fully redundant power supplies for redundancy purpose, meaning that the DPU can still work even if one main is missing or in the very unlikely case that a power supply fails.

Be sure to connect the two mains inputs to separate mains circuit and to ensure maximum redundancy.

D: SPEAKON 4 POLES INPUTS

These power inputs must be connected to the power outputs of the NEXO NXAMP or NXAMPmk2 powered TDC controller.

- Connect the NXAMPmk2 “Speakon A” output to the DPU “Input A” input.
- Connect the NXAMPmk2 “Speakon C” output to the DPU “Input C” input.

⚠ WARNING!

Use 4 x 4 mm² (AWG11) cable and four poles speakON to connect NXAMPmk2 power outputs to DPU inputs (2 meters / 16 feet max).

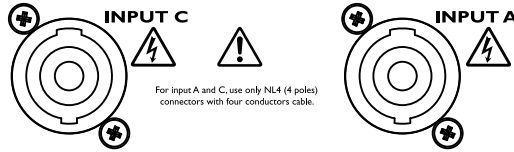

⚠ WARNING!

This ⚠ mark indicates a dangerous electrically live terminal.

When connecting an external wire to this terminal, it is necessary either to have “a person who have received appropriate guidance on handling” make the connection or to use leads or a cord that have been manufactured in such way that the connection can be made simply and without problem.

E: RS232 PORT

Connect this serial port to NXAMPmk2 RS232 port using a shielded crossover (null-modem) cable only (2 meters / 16 feet max) with female db9 connectors on each side. Below is the cable to be used to connect NXAMPmk2 to DPU pinout.

NXAMP serial port pins		DPU serial port pins
2 (RXD)	← NXAMP Receive ←	3 (TXD)
3 (TXD)	→ NXAMP Transmit →	2 (RXD)
5 (GND)	Signal ground	5 (GND)
Other	Unused	Other

NB: A cable kit for DPU containing

- 2 x 4 poles 4 x 4mm² speakON cable
 - 1 x db9 crossover (null-modem) cable
 - 2 x IEC mains cable with lockable connector (available with EU or US plugs)
- can be purchased from NEXO separately.

OPERATING THE DPU

Using the DPU is straightforward, as there is nothing to set up. The only requirement is that the NXAMPmk2 firmware supports the DPU, otherwise it will stay in Stand-by mode with nothing patched on its front panel connectors.

⚠ WARNING!

NXAMPmk2 firmware should be at least **LOAD3_11** for the DPU to work. If not, the DPU will stay in stand-by with nothing routed on its outputs

CONNECTIONS AND START UP

Be sure that the host NXAMPmk2 and the DPU are both disconnected from mains.

Connect the two four poles speakON cables between NXAMPmk2 (Speakon A and C) and DPU (Input A and C) and connect the RS232 port between the NXAMPmk2 and the DPU using a crossover cable (see serial port cabling above).

Then connect at least one IEC cable to one of the IEC mains inlets of the DPU. The left most display should light and the message “Stand-by” should appear on the screen.

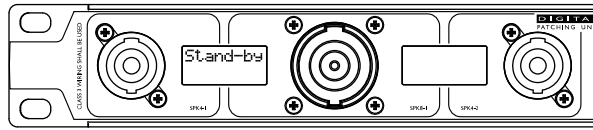

Connect the NXAMPmk2 mains plug(s) and turn the NXAMPmk2 “ON”. Check the LOAD revision while booting up; it should be **LOAD3_11** or above.

After a few second the current selected speakers on the NXAMPmk2 are routed inside the DPU and their names are displayed on the DPU screens.

DPU FRONT PANEL CONNECTORS ROUTING

The front panel of the DPU is very symmetrical and shows two groups (one on grey background, the other one on black background), both with two SPK4 and one SPK8.

For each of these blocks, the internal routing of SPK4 and SPK8 is done like on the bellow picture.

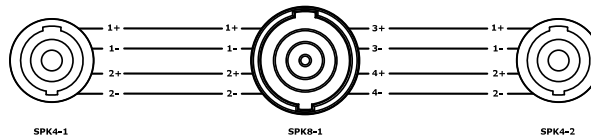

This means that SPK4 and SPK8 are always connected (hardwired) in parallel. In most of the cases, only one of these plugs will be used at a time, but this parallel wiring can be useful to carry two SPK4 outputs over a SPK8 long cable for example (with breakout box at the other end) or to link several amplifiers together (see further in this manual).

Of course, the routing from the amplifier output to these front panel connectors is done dynamically regarding the combination of four speakers’ setups done into the NXAMPmk2.

DPU DISPLAYED INFORMATION

Two next speakON (one SPK4 and one SPK8) will share the same LCD display. In case of SPK4 output, the displays will indicate some information regarding the following pinout:

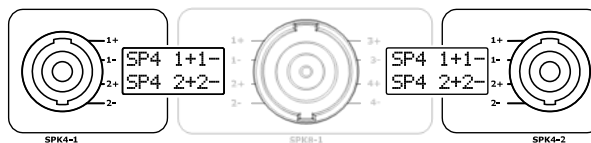

Now if SPK8 output shall be used, the displays will indicate some information regarding the following pinout:

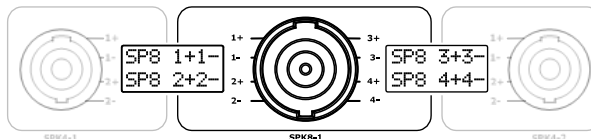

Of course, the same rules apply to the next set of front panel connectors.

There are three kinds of information displayed alternatively on the DPU screens. But the speakON to use is always indicated clearly with arrows next to the plug in use.

(1) Speaker Name

The speaker name is indicated next to each plug to be used. For example, bellow for a set of PS15R2.

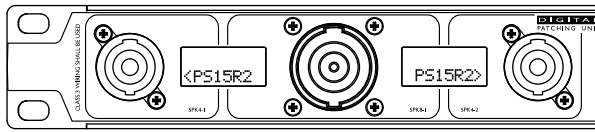

You will notice that the second line of the display is used, meaning that the output is on the 2+/2- pair of each speakON 4 connector. Note the arrow to each SPK4 connector.

For an Alpha setup, using speakON 8 connector:

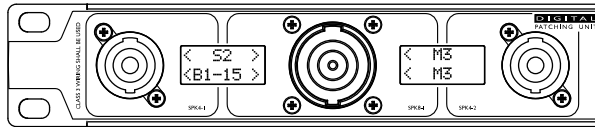

The S2 and the B1-15 have an arrow to each side (one to the SPK8, the other one to the SPK4) because you can either use a SPK4 to connect directly the S2 and the B1-15 or you can use a SPK8 to a M3 cabinet, from which you will link a S2 or B1-15 using a SPK4.

The M3 cabinet can be connected using SPK8 only so it shows only arrow to this plug. Note that the M3 text is displayed on both lines because it is an active speaker using both 3+/3- pair and 4+/4- pair of the SPK8 connector.

(2) Speaker Mode

For some setups, the mode is shown also on the display alternatively. For example, for our PS15R2 setup, if you edit the setup for Channel 2 and select a monitor setup, the DPU display above will alternate with:

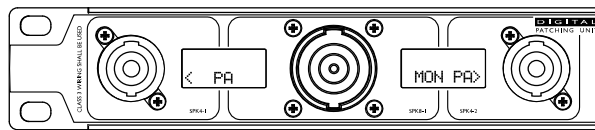

This information indicates that the PS15R2 to be connected on the first SPK4 should be a passive (PA) cabinet, the one connected to the second SPK4 will be passive (PA) also but uses a Monitor setup.

For our Alpha example, the S2 and the B1-15 has no alternate information to display but the M3 output will show that 3+/3- pins are connected to the MF whereas the 4+/4- are connected to the HF speaker of the cabinet.

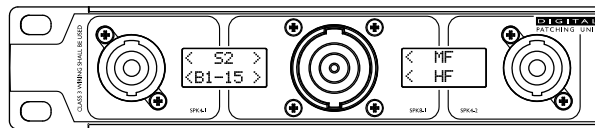

(3) Amplifier channel

The amplifier channel in use on each output is also shown alternatively with the displays above. For example, in the four PS15R2 channels case:

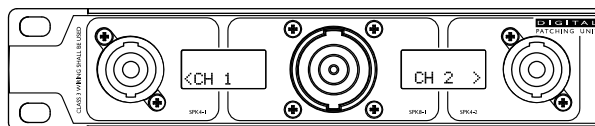

And in our Alpha setup example:

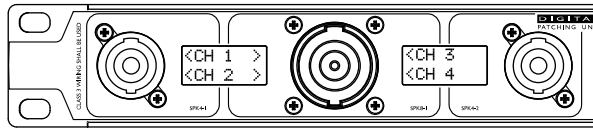

UNUSED FRONT PANEL CONNECTORS

The DPU will always try to use the maximum of outputs available to fit all the need of the user without external adaptor or difficult cabling. Thus, sometimes the same channel is routed on several outputs.

Even if the DPU will never output a speaker signal on a wrong pinout, check the display information to be sure to load the wanted amplifier channel.

In the bellow example, a setup using PS10R2/LS600/PS8/LS400 is selected.

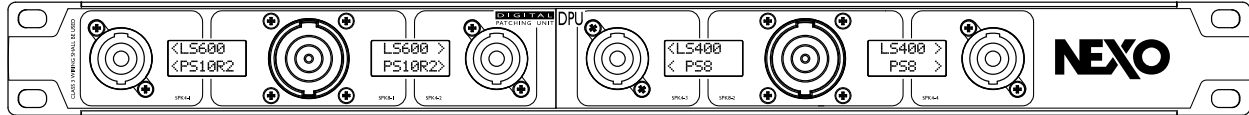

Note that each amplifier channel is duplicated on several output, allowing to have the same cable to feed PS (on 2+/2-) and LS (on 1+/1-) or use separate cable.

NB: In the example above, if you want to have PS10R2 and LS400 on the same cable, then a setup with PS10R2/LS400/PS8/LS600 should be recalled.

LINKING SEVERAL DPU TOGETHER

With some speaker's setup it could be useful to link several DPUs together. For example, with active setups, using NXAMP4x1mk2 for HF and NXAMP4x2mk2 for LF, or with GeoT setups, requiring more than one NXAMPmk2 to feed all channels, or with STM to feed a four way system using bridge amplifiers.

Each time a DPU has nothing displayed on a line of one of its displays it means that the corresponding pins on the associated speakON connectors are floating. Thus, it can be feed with other DPU output.

The following example will show how to connect two DPUs together to feed a speakON 8 connector to a complete STM system (S118 + B112 + M46).

- First NXAMP4x4mk2 will run STM M46 + B112 in stacked mode, feeding Main boxes M46 in active on two channels, and the STM bass box B112 on two other bridged channels. The DPU outputs will then be:

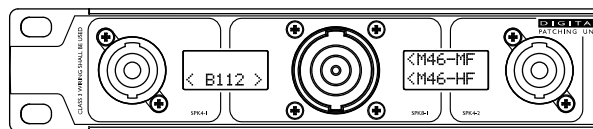

Note that the 1+/1- pins of the first SPK4 are not connected to anything and that the corresponding display line is empty.

- Second NXAMP4x4mk2 will run S118 in Omni mode on two other bridged channels.

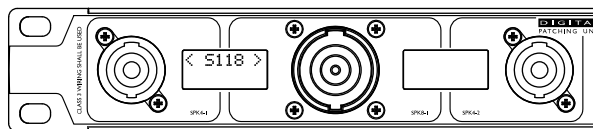

Note that this time the 2+/2- pins on the first SPK4 are not used.

We will now use a SPK4 link cable to plug to link the first SPK4 output of the second DPU in the first SPK4 output of the first DPU. Thus, the S118 signal will be also available on the SPK8, together with B112 and M46 allowing the user to have only one speakON 8 cable to feed up to 3 x S118, 3 x B112 and 3 x M46.

REMOTE CONTROL – NEXO NeMo

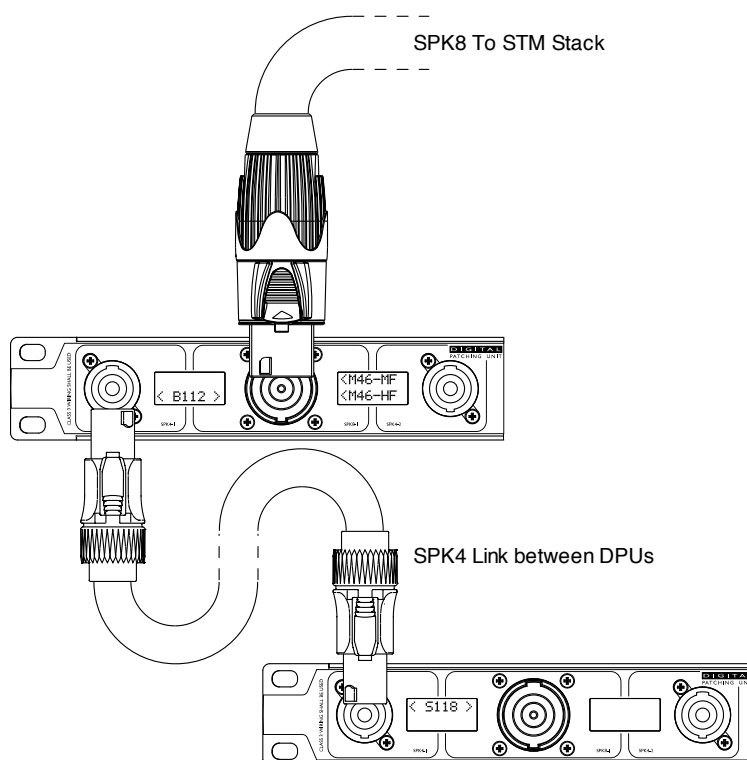

REMOTE CONTROL – NEXO NEMO

IP BASED REMOTE CONTROL PROTOCOL

NXAMPmk2 can be remote control through an Ethernet network, using the default NXR104 card fitted into the NXAMPmk2 expansion slot, or one of the optional digital audio input cards, all featuring Ethernet port for the remote control.

Both RJ45 port on the NXR104 card are internally connected to a 100BASE-TX switch. Connect one of the two RJ45 ports to the remote-control network. The other port can be used to daisy chain to other NXAMPmk2 devices. Use STP (Shielded Twisted Pair) cable to prevent electromagnetic interference.

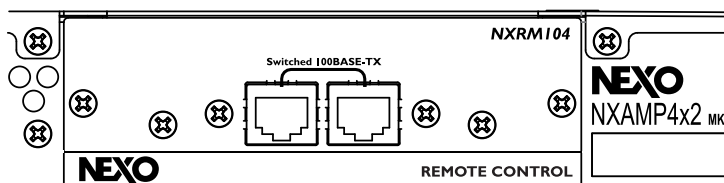

Remote control is IP based. There is no setup for IP address, it will be done automatically by the NXAMPmk2, although more advanced IP setup can be done through the NXAMPmk2 front panel if needed. By default:

- When no DHCP server is running on the network (typical simple network with remote control computer directly connected on the NXAMPmk2), the NXAMPmk2 will automatically choose a unique IP address.
- When a DHCP server is running on the network (typical network using a wireless router for example), a unique IP address will be affected by the DHCP to the NXAMPmk2.

In both case user does not have to worry about IP address settings. However, it is possible to set a static IP address to the NXAMPmk2, please refer to [Remote Control Settings](#).

NEMO (NEXO REMOTE): NXAMPMK2 CONTROL SOFTWARE

NEXO NeMo is the remote control app of a set of NEXO products (NXAMP Powered TD-controllers, DTD Digital TD-controllers). It allows you to control from an Apple iPad, iPhone, iPod Touch through a Wi-Fi network and from a Mac through a wired or Wi-Fi network one or many NEXO devices.



Managing and positioning amplifiers, monitoring their parameters (levels, etc.), and setting new values (preset, volume, delay, EQ, etc.) is made possible thanks to an attractive and intuitive user interface. NEXO NeMo also comes with a powerful engine for logging, alerting and emailing.

Its main functionalities include:

- Creating and editing offline sessions and matching to real NEXO devices when going online (macOS only).
- Intelligent matching of online and offline devices (macOS only), and a way of locating the online devices.
- Visualizing and positioning the connected NEXO devices within a 2D space.
- Adding custom background pictures and editing their brightness and blurriness.
- Grouping devices or channels for multi-device control, and visualizing groups and zones on the 2D space.
- Quickly muting, soloing, and monitoring the status of devices, groups or zones, including peak and protect, for the entire network.
- Selecting setups from the standard library and building custom setups.
- Monitoring and controlling simultaneously parameters of several NEXO devices, among which mute-solo, input and output levels, and volume, delay, gain, array-EQ and headroom of each output channel.
- Patching input channels to output channels.
- Viewing and editing EQ and compressor. EQs can be saved in an EQ Library.
- Saving and recalling scenes (NXAMP only).
- Undoing and redoing every control step.
- Copying and pasting parameters and scenes from one to many NEXO devices.
- Saving and sharing user configurations, thanks to Sessions (.nemo documents).
- A configurable way of managing alerts of different levels.
- Visualizing and exporting a log of all the values of the NEXO devices (including temperature, voltage, current...) that you can record when NeMo is online.

- A fully configurable Live mode.
- A Demo mode to test the app.
- A use in portrait on iPhone and iPad, and in portrait or landscape mode on iPad. A use in full-screen on Mac.

OTHER REMOTE-CONTROL OPTIONS

Note that NEXO NeMo is not the only possible remote-control client for your NXAMPmk2s:

- AVS-Monitor offers a compatibility remote-control software on Windows.
- Yamaha's ProVisionaire integrates basic remote-control features of the NXAMPmk2. With this software, it is possible to build custom control spaces combining various Yamaha and NEXO products, suited to your needs.
- Yamaha's CL and QL mixing consoles also integrate basic remote-control features of the NXAMPmk2.
- The documentation about remote-control protocol, called NEXO Direct Control, is available upon request. As it is based on TCP/IP, it can be integrated into many system management solutions such as Q-SYS or Crestron.

FIRMWARE UPDATE – NEXO NEFU

Like any digital devices, firmware upgrade can provide new functions (such as NEXO Speakers Presets) and bug fixes in the NXAMPmk2.

The firmware file (LOADX_XX) can be downloaded from the NEXO website and installed through an Ethernet network, using the default NXR104 card fitted into the NXAMPmk2 expansion slot, or one of the optional digital audio input cards, all featuring Ethernet port.

To proceed to the firmware update of the NXAMPmk2 device, it is necessary to use NEXO NeFu. The installation file of NEXO NeFu is provided with the LOAD firmware package which is available on the NEXO website.



NEXO NeFu is the NEXO firmware update software for NEXO devices. It allows you to simultaneously update a set of amplifiers (NXAMPmk2 and NEXO NXAMP Powered TD-controllers).

NEXO NeFu software runs on both Windows and macOS computers.

Its main functionalities include:

- Automatically detecting devices through the network.
- Viewing and verifying all necessary information about the device updating.
- Loading a firmware file and viewing all versions of targeted systems.
- Performing an intelligent update of all device's parts (NXAMPmk2 and expansion slot).
- Simultaneous update.
- Automatically notifying for new application and firmware version.
- Better error handling.
- Exporting a log of the update process.

Check out our web site nexo-sa.com for more information about NEXO NeFu features and the latest released version.

ACCESSORIES

NXDT104MK2

Dante™ card, 4 audio streams (24-bits / 48 or 96kHz) and remote control.

3-port design (3 port Gigabit Switch or 2 Dante™ redundant ports + remote control).



NXES104

EtherSound™ card, extracts 4 audio streams (24-bits / 48kHz) from the 2 x 64 channels of an ES100 EtherSound™ stream.

In and Out ports for easy daisy-chaining, third port for remote control.



NXAE104

AES/EBU card, receives 4 audio channels (24-bits / 44.1 - 96kHz) in AES/EBU format.

2 x AES/EBU stereo XLR inputs; 1 x AES/EBU buffered output with fail-safe relay and 2 x switched RJ45 ports enable remote control and easy daisy chaining.



NXRM104

2 x RJ45 ports enable remote control and easy daisy chaining, while also facilitating firmware update

Supplied as standard with the NXAMPmk2.



DMU

The DMU enables easy monitoring of all activity on the NXAMPmk2's audio inputs, with signal and power supply coming from the amplifier's GPIO port.

Front panel features include four analogue XLR inputs plus link, three RJ45 ports for digital audio networking and LED VU meters.



DPU

The DPU optimizes the NXAMPmk2's channel by channel preset selection by automatically routing its outputs to any of six output connectors on the DPU front panel.

Cabinet names and bridging status are displayed alongside each output, making it easy to wire the system.



MAINTENANCE

Hardware maintenance

 **WARNING!**

Always unplug the NXAMPmk2 from the main before cleaning it.

Regularly check the dust level of the air intakes of the NXAMPmk2. If some dust is inserted into the cooling tunnel of the amplifier, use compressed air to remove it from the amplifier.

The chassis and the front panel can be cleaned using a dry cloth.

TECHNICAL SPECIFICATIONS

	NXAMP4x1mk2	NXAMP4x2mx2	NXAMP4x4mk2
Power specifications			
Number of channels	4 x amplifiers channel, 2 by 2 bridgeable		
Max. output voltage (no load)	4 x 105 Volts	4 x 140 Volts	4 x 180 Volts
Max. output power (4x8 Ohms)	4 x 600 Watts	4 x 1200 Watts	4 x 1900 Watts
Max. output power (4x4 Ohms)	4 x 900 Watts	4 x 1900 Watts	4 x 3300 Watts
Max. output power (4x2 Ohms)	4 x 1300 Watts	4 x 2500 Watts	4 x 4500 Watts
Max. bridge power (2x8 Ohms)	2 x 1800 Watts	2 x 3800 Watts	4 x 6600 Watts
Audio characteristics			
Frequency response	+/-1 dB from 20 Hz to 20 kHz		
Input impedance	20 kOhms		
Input sensitivity (8 Ohms)	+13 dBu	+16 dBu	+18 dBu
Nominal gain	26 dB		
Dynamic range (A-weighted)	110 dB		
THD+N	Typical 0.01%		
Back panel features			
Analog audio input	4 x balanced analog inputs		
Power output	4 x NL4 outputs, 4 poles connectors		
Main sockets	PowerCon 20A with secure lock		
	1		2
Front panel features			
Switch and knobs	Pushable rotary encoder with surrounding LEDs		
Screen	4.3" diagonal WGVGA (480 x RGB x 272) TFT LCD touch screen		
Mains requirements			
Mains voltage	Universal power supply with active PFC 100 – 240 Volts (50/60Hz)		
Power consumption	See <i>Thermal Dissipation and Current Drawn</i> section		
Physical specifications			
Dimensions (W x H x D)	480 x 88 x 502, 19" / 2U		480 x 132 x 502, 19"
Weight	15.7 kg (33.1 lbs)	16.1 kg (35.3 lbs)	24.9 kg (54.8 lbs)
Operating temperature range	0°C to +40°C (+32°F to +104°F)		
Storage temperature range	-20°C to +60°C (-4°F to +140°F)		
Certifications			
CE conformity	2014/35/EU (Low voltage) 2014/30/EU (EMC) 2011/65/EU (RoHS)		
Electrical safety certification	CSA / CB / EN60065		
EMC certification	EN55032 / EN55103-2 / FCC		
Power cable			
Included for all destination	PowerCon 20A to CEE form 32A mono*		
	1		2

(*) Other power cables are available from NEXO. Please ask NEXO distributor.

THERMAL DISSIPATION AND CURRENT DRAWN

For these measurements, the test signal is a pink noise with bandwidth limited 22 Hz to 22 kHz, all channels driven.

1 BTU = 1055.06 J = 0.252 kcal.

(W) x 860 = cal/h

NXAMP4X1MK2 (PINK NOISE, 100 V/50 HZ MAINS)

	MODE	Output/ch		Line Current (A)	Power Consumption (W)	Watts Dissipated (W)	Heat Dissipation	
		Power(W)	Volt(V)				Btu/h	kcal/h
Standby		0.0	0.0	0.17	6.4	6.4	22	6
Idle		0.0	0.0	1.81	167	167	570	144
1/8 output power	8ohms/ch	75.0	24.5	5.42	520	220	751	189
	4ohms/ch	112.5	21.2	7.46	736	286	976	246
	2ohms/ch	162.5	18.0	10.6	1058	408	1392	351
1/4 output power	8ohms/ch	150.0	34.6	8.92	880	280	956	241
	4ohms/ch	225.0	30.0	13.0	1300	400	1365	344
	2ohms/ch	325.0	25.5	19.8	1946	646	2205	556
1/3 output power	8ohms/ch	200.0	40.0	11.45	1138	338	1153	291
	4ohms/ch	300.0	34.6	16.91	1688	488	1665	420
	2ohms/ch	433.3	29.4	25.03	2500	767	2616	659

NXAMP4X1MK2 (PINK NOISE, 120 V/60 HZ MAINS)

	MODE	Output/ch		Line Current (A)	Power Consumption (W)	Watts Dissipated (W)	Heat Dissipation	
		Power(W)	Volt(V)				Btu/h	kcal/h
Standby		0.0	0.0	0.21	6.4	6.4	22	6
Idle		0.0	0.0	1.52	161	161	549	138
1/8 output power	8ohms/ch	75.0	24.5	4.44	512	212	723	182
	4ohms/ch	112.5	21.2	6.24	724	274	935	236
	2ohms/ch	162.5	18.0	8.88	1047	397	1355	341
1/4 output power	8ohms/ch	150.0	34.6	7.41	866	266	908	229
	4ohms/ch	225.0	30.0	10.7	1275	375	1280	323
	2ohms/ch	325.0	25.5	16.0	1892	592	2020	509
1/3 output power	8ohms/ch	200.0	40.0	9.45	1123	323	1102	278
	4ohms/ch	300.0	34.6	13.92	1662	462	1577	397
	2ohms/ch	433.3	29.4	20.53	2459	726	2476	624

THERMAL DISSIPATION AND CURRENT DRAWN

NXAMP4X1MK2 (PINK NOISE, 230 V/50 HZ MAINS)

	MODE	Output/ch		Line Current (A)	Power Consumption (W)	Watts Dissipated (W)	Heat Dissipation	
		Power(W)	Volt(V)				Btu/h	kcal/h
Standby		0.0	0.0	0.32	10.3	10.3	35	9
Idle		0.0	0.0	1.03	163	163.0	556	140
1/8 output power	8ohms/ch	75.0	24.5	2.52	506	206.0	703	177
	4ohms/ch	112.5	21.2	3.47	711	261.0	891	224
	2ohms/ch	162.5	18.0	4.89	1019	369.0	1259	317
1/4 output power	8ohms/ch	150.0	34.6	4.11	850	250.0	853	215
	4ohms/ch	225.0	30.0	5.86	1237	337.0	1150	290
	2ohms/ch	325.0	25.5	8.52	1842	542.0	1850	466
1/3 output power	8ohms/ch	200.0	40.0	5.31	1095	295	1007	254
	4ohms/ch	300.0	34.6	7.57	1613	413	1409	355
	2ohms/ch	433.3	29.4	10.82	2370	637	2173	548

NXAMP4X2MK2 (PINK NOISE, 100 V/50 HZ MAINS)

	MODE	Output/ch		Line Current (A)	Power Consumption (W)	Watts Dissipated (W)	Heat Dissipation	
		Power(W)	Volt(V)				Btu/h	kcal/h
Standby		0.0	0.0	0.16	6.3	6.3	22	5
Idle		0.0	0.0	2.05	189	189.0	645	163
1/8 output power	8ohms/ch	150.0	34.6	9.48	946	346.0	1181	298
	4ohms/ch	237.5	30.8	14.6	1413	463.0	1580	398
	2ohms/ch	312.5	25.0	18.4	1881	631.0	2153	543
1/4 output power	8ohms/ch	300.0	49.0	17.5	1685	485.0	1655	417
	4ohms/ch	475.0	43.6	25.8	2607	707.0	2413	608
	2ohms/ch	625.0	35.4	36.9	3598	1098.0	3747	944
1/3 output power	8ohms/ch	400.0	56.6	21.25	2133	533	1819	458
	4ohms/ch	633.3	50.3	34.22	3425	892	3043	767
	2ohms/ch	833.3	40.8	47.73	4775	1442	4920	1240

NXAMP4X2MK2 (PINK NOISE, 120 V/60 HZ MAINS)

	MODE	Output/ch		Line Current (A)	Power Consumption (W)	Watts Dissipated (W)	Heat Dissipation	
		Power(W)	Volt(V)				Btu/h	kcal/h
Standby		0.0	0.0	0.21	6.7	6.7	23	6
Idle		0.0	0.0	1.76	190	190.0	648	163
1/8 output power	8ohms/ch	150.0	34.6	7.74	904	304.0	1037	261
	4ohms/ch	237.5	30.8	11.6	1375	425.0	1450	366
	2ohms/ch	312.5	25.0	15.7	1857	607.0	2072	522
1/4 output power	8ohms/ch	300.0	49.0	13.8	1632	432.0	1474	372
	4ohms/ch	475.0	43.6	21.9	2565	665.0	2269	572
	2ohms/ch	625.0	35.4	29.1	3480	980.0	3344	843
1/3 output power	8ohms/ch	400.0	56.6	17.55	2097	497	1696	427
	4ohms/ch	633.3	50.3	27.73	3337	804	2743	691
	2ohms/ch	833.3	40.8	37.93	4563	1230	4196	1058

NXAMP4X2MK2 (PINK NOISE, 230 V/50 HZ MAINS)

	MODE	Output/ch		Line Current (A)	Power Consumption (W)	Watts Dissipated (W)	Heat Dissipation	
		Power(W)	Volt(V)				Btu/h	kcal/h
Standby		0.0	0.0	0.32	9.7	9.7	33	8
Idle		0.0	0.0	1.11	179	179.0	611	154
1/8 output power	8ohms/ch	150.0	34.6	4.21	873	273.0	932	235
	4ohms/ch	237.5	30.8	6.27	1332	382.0	1304	329
	2ohms/ch	312.5	25.0	8.19	1782	532.0	1816	458
1/4 output power	8ohms/ch	300.0	49.0	7.32	1573	373.0	1273	321
	4ohms/ch	475.0	43.6	11.1	2451	551.0	1880	474
	2ohms/ch	625.0	35.4	14.5	3356	856.0	2921	736
1/3 output power	8ohms/ch	400.0	56.6	9.31	2025	425	1450	366
	4ohms/ch	633.3	50.3	14.27	3191	658	2244	566
	2ohms/ch	833.3	40.8	19.12	4316	983	3354	845

THERMAL DISSIPATION AND CURRENT DRAWN

NXAMP4X4MK2 (PINK NOISE, 100 V/50 HZ MAINS)

	MODE	Output/ch		Line Current (A)	Power Consumption (W)	Watts Dissipated (W)	Heat Dissipation	
		Power(W)	Volt(V)				Btu/h	kcal/h
Standby		0.0	0.0	0.28	6.4	6.4	22	6
Idle		0.0	0.0	3.02	271	271	925	233
1/8 output power	8ohms/ch	237.5	43.6	15.04	1460	510	1740	439
	4ohms/ch	412.5	40.6	24.65	2413	763	2604	656
	2ohms/ch	562.5	33.5	34.58	3362	1112	3795	956
1/4 output power	8ohms/ch	475.0	61.6	26.82	2622	722	2464	621
	4ohms/ch	825.0	57.4	46.87	4518	1218	4157	1047
	2ohms/ch	1125.0	47.4	68.07	6460	1960	6689	1686
1/3 output power	8ohms/ch	633.3	71.2	33.95	3426	893	3047	768
	4ohms/ch	1100.0	66.3	56.20	5970	1570	5358	1350
	2ohms/ch	1500.0	54.8	83.00	8660	2660	9078	2288

NXAMP4X4MK2 (PINK NOISE, 120 V/60 HZ MAINS)

	MODE	Output/ch		Line Current (A)	Power Consumption (W)	Watts Dissipated (W)	Heat Dissipation	
		Power(W)	Volt(V)				Btu/h	kcal/h
Standby		0.0	0.0	0.39	7.1	7.1	24	6
Idle		0.0	0.0	2.64	270	270	921	232
1/8 output power	8ohms/ch	237.5	43.6	12.57	1442	492	1679	423
	4ohms/ch	412.5	40.6	20.21	2369	719	2454	618
	2ohms/ch	562.5	33.5	27.99	3287	1037	3539	892
1/4 output power	8ohms/ch	475.0	61.6	21.90	2571	671	2290	577
	4ohms/ch	825.0	57.4	37.63	4392	1092	3727	939
	2ohms/ch	1125.0	47.4	53.94	6271	1771	6044	1523
1/3 output power	8ohms/ch	633.3	71.2	27.12	3340	807	2753	694
	4ohms/ch	1100.0	66.3	48.50	5806	1406	4798	1209
	2ohms/ch	1500.0	54.8	70.60	8308	2308	7877	1985

NXAMP4X4MK2 (PINK NOISE, 230 V/50 HZ MAINS)

	MODE	Output/ch		Line Current (A)	Power Consumption (W)	Watts Dissipated (W)	Heat Dissipation	
		Power(W)	Volt(V)				Btu/h	kcal/h
Standby		0.0	0.0	0.60	9.8	9.8	33	8
Idle		0.0	0.0	1.85	264	264	901	227
1/8 output power	8ohms/ch	237.5	43.6	6.78	1411	461.0	1573	396
	4ohms/ch	412.5	40.6	10.79	2303	653.0	2228	562
	2ohms/ch	562.5	33.5	14.62	3172	922.0	3147	793
1/4 output power	8ohms/ch	475.0	61.6	11.67	2502	602.0	2054	518
	4ohms/ch	825.0	57.4	19.14	4217	917.0	3129	789
	2ohms/ch	1125.0	47.4	26.54	5943	1443.0	4925	1241
1/3 output power	8ohms/ch	633.3	71.2	14.65	3210	677	2310	582
	4ohms/ch	1100.0	66.3	24.69	5480	1080	3686	929
	2ohms/ch	1500.0	54.8	34.45	7670	1670	5699	1436

DRAWINGS AND DIMENSIONS

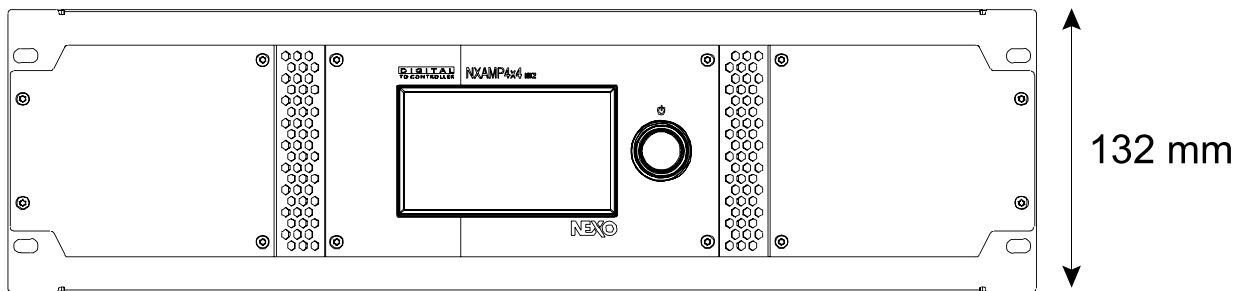
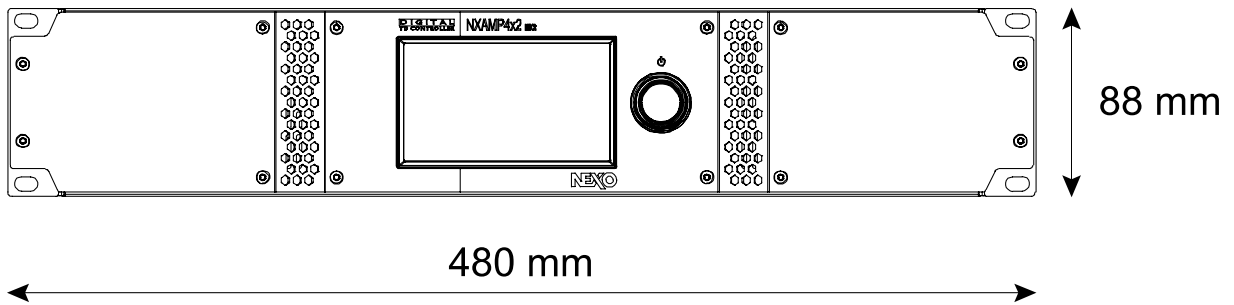

LOG AND ALERT PARAMETERS

Below is the full list of any global or per channel information that can be logged into the NXAMPmk2 or remotely, and if this piece of information can raise an alert.

Global/Ch.	Name	Description	Range	Log	Alert
Global	Mains 1, 2 Voltage	Mains voltage (in V) measured from the MAINS 1 or 2 plug at the back of the NXAMP. MAINS 2 only applies to NXAMP4x4.	0.. V	✓	
	Power Supply 1, 2 Voltage	Output voltage (in V) of the power supply feeding power amplifier 1 or 2. Power Supply 2 only applies to NXAMP4x4.	0.. V	✓	
	Input level (analog)	Peak level (in dBFS) at the output of the analog to digital converter of an analog input (A to D). Given with an accuracy of ±3dB, and at a maximum rate of 25Hz.	-60, 0dBFS	✓	
	Input level (network)	Peak level (in dBFS) of a network (E to H) input. Given with an accuracy of ±3dB, and at a maximum rate of 25Hz.	-60, 0 dBFS	✓	
	Overmute/Global mute	Mute status of the four channels. If overmute is active, the channels' mute status is preserved.	0, 1	✓	
	Limiting Output	The amplifier has to reduce its output level for protection (if too hot). Output level is reduced by 3dB if one of the power amplifier's heat sink reaches 70°C, then 3 more dB above 80°C.	0, 1	✓	✓
	Muting Output	The amplifier has to mute its output for protection (if extremely hot –more than 90°C on the heat sink– or if a problem arises on a channel, e.g. DC output detected or low power supply's output level.	0, 1	✓	✓
	Amp protect	Protection status of the amplifier. If protecting, it is reducing or muting one or several outputs due to malfunctions as overheating, output DC, or short circuit.	0, 1	✓	✓
	FAN1, 2, 3 is Stopped	Fan has stopped rotating due to error.	0, 1		✓
	Card overclocking	Extension card is overclocking.	0, 1		✓
	Card not ready	Extension card is not ready.	0, 1		✓
	Card audio err	Extension card has audio error.	0, 1		✓
Global	Analog fallback	Input patch has internally switched to analog because no digital signal could be detected.	0, 1		✓
Per channel	Power Amp Temp. (per ch.)	Temperature (in °C) of the amplifier for a channel.	0.. °C	✓	

LOG and ALERT PARAMETERS

Output voltage (per ch.)	Peak voltage (in dBFS, 0dBFS being the clip level of the voltage sense converter) of a channel (accuracy of ± 3 dB, and maximum rate of 25Hz). A non-null value informs you a signal is being sent to the output.	-60, 0 dBFS	✓	
Output current (per ch.)	Peak current (in dBFS, 0dBFS being the clip level of the current sense converter) of a channel (accuracy of ± 3 dB, and maximum rate of 25Hz). A non-null value informs you there is a load on the channel.	-60, 0 dBFS	✓	
Sense (per ch.)	A certain level of current is detected on the output (a cabinet is connected, and some sufficient signal is flowing to it).	0, 1	✓	
Protection (per ch.)	Speaker protection (displacement or thermal)	0, 1	✓	✓
Peak Limiter (per ch.)	The peak limiter is working to protect the amplifier for the channel.	0, 1	✓	✓
Mute (per ch.)	Mute status of a channel.	0, 1	✓	
Speaker Temperature (per ch.)	Voice coils temperature (in dB, 0 dB being the maximum temperature the speakers can safely reach under the current preset).	-60, 0 dB	✓	
Speaker Displacement (per ch.)	Membrane displacement (in dB, 0 dB being the maximum displacement the speakers can safely reach under the current preset).	-60, 0 dB	✓	
Speaker Protection (per ch.)	Reduction of the output levels currently applied by the NXAMP (in dB, 0 dB being no protection). It is the maximum of all protections (displacement, thermal, peak limiter, etc. see System Headroom for more detail).	0, 60 dB	✓	
Low and High Load Alert (per ch.)	Should be used in conjunction with the load monitoring function of the NXAMP (see Load Monitoring). This function allows sending a high frequency pilot tone into the NXAMP and thus monitoring the impedance of the load. If the measured impedance for a channel goes out of the user's predefined limits, or if the NXAMP cannot measure the output impedance (no pilot tone, channel muted, and so on) these alerts are raised.	0, 1		✓
PS overtemp — Power Supply Overtemperature (per ch.)	Abnormal temperature has been detected by the temperature sensor on the heat sink of the power supply.	0, 1		✓
Mains err — Power Supply Mains Error (per ch.)	The mains voltage is out of the limits (150V to 288V for the NXAMP "C" version or the "W" version started in 230V mode, and 60V to 150V for the "U" version or the "W" version started in 120V mode).	0, 1		✓
PS volt err — Power Supply Output Voltage Error (per ch.)	The output of the power supply is out of the limits (10V to 250V DC).	0, 1		✓

LICENSE INFORMATION

	Amp DC out — Power Amp DC Output Alert (per ch.)	The output DC value of a given amplifier channel is greater than 10V.	0, 1		✓
	Amp overtemp — Power Amp Overtemperature (per ch.)	Over-temperature value of the power amplifier (no over-temperature, >65°C and reducing output by 3dB, >75°C and reducing by 6dB), >80° and muting output).	0, >65°C, >75°C, >80°C		✓

LICENSE INFORMATION

This product is based in part on the work of the Independent JPEG Group.

GOOGLE ROBOTO FONT

Copyright 2011 Google Inc. All Rights Reserved.

Licensed under the Apache License, Version 2.0 (the “License”); you may not use this file except in compliance with the License.

You may obtain a copy of the License at <http://www.apache.org/licenses/LICENSE-2.0>

Unless required by applicable law or agreed to in writing, software distributed under the License is distributed on an “AS IS” BASIS, WITHOUT WARRANTIES OR CONDITIONS OF ANY KIND, either express or implied.

See the License for the specific language governing permissions and limitations under the License.

LWIP – LIGHTWEIGHT IP STACK

LwIP is licensed under a BSD-style license:

Copyright © 2001, 2002 Swedish Institute of Computer Science.

All rights reserved.

Redistribution and use in source and binary forms, with or without modification, are permitted provided that the following conditions are met:

1. Redistributions of source code must retain the above copyright notice, this list of conditions and the following disclaimer.
2. Redistributions in binary form must reproduce the above copyright notice, this list of conditions and the following disclaimer in the documentation and/or other materials provided with the distribution.
3. The name of the author may not be used to endorse or promote products derived from this software without specific prior written permission.

THIS SOFTWARE IS PROVIDED BY THE AUTHOR “AS IS” AND ANY EXPRESS OR IMPLIED WARRANTIES, INCLUDING, BUT NOT LIMITED TO, THE IMPLIED WARRANTIES OF MERCHANTABILITY AND FITNESS FOR A PARTICULAR PURPOSE ARE DISCLAIMED. IN NO EVENT SHALL THE AUTHOR BE LIABLE FOR ANY DIRECT, INDIRECT, INCIDENTAL, SPECIAL, EXEMPLARY, OR CONSEQUENTIAL DAMAGES (INCLUDING, BUT NOT LIMITED TO, PROCUREMENT OF SUBSTITUTE GOODS OR SERVICES; LOSS OF USE, DATA, OR PROFITS; OR BUSINESS INTERRUPTION) HOWEVER CAUSED AND ON ANY THEORY OF LIABILITY, WHETHER IN CONTRACT, STRICT LIABILITY, OR TORT (INCLUDING NEGLIGENCE OR OTHERWISE) ARISING IN ANY WAY OUT OF THE USE OF THIS SOFTWARE, EVEN IF ADVISED OF THE POSSIBILITY OF SUCH DAMAGE.

WEEE INFORMATION

INFORMATION FOR USERS ON COLLECTION AND DISPOSAL OF OLD EQUIPMENT:



This symbol on the products, packaging, and/or accompanying documents means that used electrical and electronic products should not be mixed with general household waste.

For proper treatment, recovery and recycling of old products, please take them to applicable collection points, in accordance with your national legislation.

By disposing of these products correctly, you will help to save valuable resources and prevent any potential negative effects on human health and the environment which could otherwise arise from inappropriate waste handling.

For more information about collection and recycling of old products, please contact your local municipality, your waste disposal service or the point of sale where you purchased the items.

For business users in the European Union:

If you wish to discard electrical and electronic equipment, please contact your dealer or supplier for further information.

Information on Disposal in other Countries outside the European Union:

This symbol is only valid in the European Union. If you wish to discard these items, please contact your local authorities or dealer and ask for the correct method of disposal.

(weee_eu_en_02)

VERBRAUCHERINFORMATION ZUR SAMMLUNG UND ENTSORGUNG ALTER ELEKTROGERÄTE:



Befindet sich dieses Symbol auf den Produkten, der Verpackung und/oder beiliegenden Unterlagen, so sollten benutzte elektrische Geräte nicht mit dem normalen Haushaltsabfall entsorgt werden.

In Übereinstimmung mit Ihren nationalen Bestimmungen bringen Sie alte Geräte bitte zur fachgerechten Entsorgung, Wiederaufbereitung und Wiederverwendung zu den entsprechenden Sammelstellen.

Durch die fachgerechte Entsorgung der Elektrogeräte helfen Sie, wertvolle Ressourcen zu schützen, und verhindern mögliche negative Auswirkungen auf die menschliche Gesundheit und die Umwelt, die andernfalls durch unsachgerechte Müllentsorgung auftreten könnten.

Für weitere Informationen zum Sammeln und Wiederaufbereiten alter Elektrogeräte kontaktieren Sie bitte Ihre örtliche Stadt- oder Gemeindeverwaltung, Ihren Abfallentsorgungsdienst oder die Verkaufsstelle der Artikel.

Information für geschäftliche Anwender in der Europäischen Union:

Wenn Sie Elektrogeräte ausrangieren möchten, kontaktieren Sie bitte Ihren Händler oder Zulieferer für weitere Informationen.

Entsorgungsinformation für Länder außerhalb der Europäischen Union:

Dieses Symbol gilt nur innerhalb der Europäischen Union. Wenn Sie solche Artikel ausrangieren möchten, kontaktieren Sie bitte Ihre örtlichen Behörden oder Ihren Händler und fragen Sie nach der sachgerechten Entsorgungsmethode.

(weee_eu_de_02)

INFORMATIONS CONCERNANT LA COLLECTE ET LE TRAITEMENT DES DECHETS D'EQUIPEMENTS ELECTRIQUES ET ELECTRONIQUES



Le symbole sur les produits, l'emballage et/ou les documents joints signifie que les produits électriques ou électroniques usagés ne doivent pas être mélangés avec les déchets domestiques habituels.

Pour un traitement, une récupération et un recyclage appropriés des déchets d'équipements électriques et électroniques, veuillez les déposer aux points de collecte prévus à cet effet, conformément à la réglementation nationale.

En vous débarrassant correctement des déchets d'équipements électriques et électroniques, vous contribuerez à la sauvegarde de précieuses ressources et à la prévention de potentiels effets négatifs sur la santé humaine qui pourraient advenir lors d'un traitement inapproprié des déchets.

Pour plus d'informations à propos de la collecte et du recyclage des déchets d'équipements électriques et électroniques, veuillez contacter votre municipalité, votre service de traitement des déchets ou le point de vente où vous avez acheté les produits.

Pour les professionnels dans l'Union européenne :

Si vous souhaitez vous débarrasser des déchets d'équipements électriques et électroniques, veuillez contacter votre vendeur ou fournisseur pour plus d'informations.

Informations sur la mise au rebut dans d'autres pays en dehors de l'Union européenne :

Ce symbole est seulement valable dans l'Union européenne. Si vous souhaitez vous débarrasser de déchets d'équipements électriques et électroniques, veuillez contacter les autorités locales ou votre fournisseur et demander la méthode de traitement appropriée.

(weee_eu_fr_02)

INFORMACION PARA USUARIOS SOBRE LA RECOGIDA Y ELIMINACION DE LOS EQUIPOS ANTIGUOS



Este símbolo en los productos, embalajes y documentos anexos significa que los productos eléctricos y electrónicos no deben mezclarse con los desperdicios domésticos normales.

Para el tratamiento, recuperación y reciclaje apropiados de los productos antiguos, lívelos a puntos de reciclaje correspondientes, de acuerdo con la legislación nacional.

Al deshacerse de estos productos de forma correcta, ayudará a ahorrar recursos valiosos y a impedir los posibles efectos desfavorables en la salud humana y en el entorno que de otro modo se producirían si se tratan los desperdicios de modo inapropiado.

Para obtener más información acerca de la recogida y el reciclaje de los productos antiguos, póngase en contacto con las autoridades locales, con el servicio de eliminación de basuras o con el punto de venta donde adquirió los artículos.

Para los usuarios empresariales de la Unión Europea:

Si desea desechar equipos eléctricos y electrónicos, póngase en contacto con su vendedor o proveedor para obtener más información.

Información sobre la eliminación en otros países fuera de la Unión Europea:

Este símbolo solo es válido en la Unión Europea. Si desea desechar estos artículos, póngase en contacto con las autoridades locales o con el vendedor y pregúnteles el método correcto.

(weee_eu_es_02)

NEXO S.A.
Parc d'Activité
Du Pré de la Dame Jeanne
B.P.5
60128 Plailly
FRANCE

Tel : +33 (0)3 44 99 00 70
Fax : +33 (0)3 44 99 00 30
E-mail : info@nexo.fr
nexo-sa.com

The logo for NEXO, featuring the word "NEXO" in a bold, black, sans-serif font. The letter 'X' is stylized with a diagonal slash through it.