



ER-5700, ER-5900

UHF DUAL CHANNEL WIRELESS MICROPHONE SYSTEM

 100% recycled paper
100% papier recyclé

Installation and Operation

Contents

01 Safety Operation and Notice	P3
02 System Performance Feature	P4
03 Receiver Installation Method	P5
04 Packing List	P6
05 Receiver Front Panel Function Introduction	P7
06 Receiver Rear Panel Function Introduction	P9
07 Transmitter Function Introduction	P10
Handheld microphone (EH-38, EH-59)	P10
Bodypack microphone (ET-50)	P12
Desktop gooseneck microphone (UD-2)	P14
08 Transmitter Battery Installation	P16
09 System Setup	P18
Receiver Setup	P18
Operating menu of the Receiver	P19
10 User simple steps	P20
11 Technical Specification	P23

Thank you for choosing a RELACART professional wireless microphone system. You have joined thousands of other satisfied customers. Our years of professional experience of design and manufacturing to ensure our products' quality, performance and reliability.

01 Safety Operation and Notice

1. Please read instructions for safety operation carefully before installation and operation. Please save your safety operation guide for future reference.
2. Do not scratch, bend, twist, stretch or heat the power cord as this may cause damage to the power cord, resulting in a fire or electric shock.
3. Do not open the device shell, otherwise it may cause electric shock. If you need to repair, maintain or repair, please contact your local agent.
4. Do not touch the power plug with wet hands as this may cause a fire or electric shock.
5. Do not attempt to modify this device. Failure to do so may result in personal injury or product malfunction.
6. Do not use this equipment near water.
7. If the power cord is damaged (such as a broken wire or bare core), obtain replacement parts from your dealer. Continued use of the equipment with a damaged power cord may result in fire or electric shock.
8. To move the device he power, unplug the power cord, and unplug all connecting cables as this may damage the cable, resulting in a fire or electric shock.
9. Before cleaning the device, unplug the power cord and unplug all connecting cables. Please clean it with a dry soft cloth.
10. If the device is not in use for a long time, turn off the power, it is best to unplug the socket.
11. With the power plug and appliance coupler as the disconnecting device, it should be kept easy to operate.
12. For the safe use of the equipment and adequate ventilation, the minimum clearance around the equipment should be maintained at a distance of 5 cm or more.
13. DO NOT cover the Ventilation holes, such as: newspaper / fabric / curtains and other items.
14. Equipment should not be placed on a bare flame source, such as: lit candles.
15. Battery should not be exposed to sunshine, roasted or other high temperature overheating environment.
16. Do not throw the waste battery, please put in the designated bins.
17. Water protection rating: IPX0
18. The device can be used normally in tropical / temperate climates.
19. This product is only suitable for safe use at the altitude of 2000m and below.
20. This symbol "⚡" indicates that dangerous voltage constituting a risk of electric shock is present within this unit.
21. All Relacart products will be afforded one year free maintenance except for man-made damage, such as:
 - the device is damaged by man-made factors.
 - the device is damaged by improper operation.
 - some components are damaged or loss after the self-disassembly.

02 System Performance Feature

ER series is a dual-channel true diversity wireless microphone. True diversity receiving mode is more stable, with AFS function, eliminating the reception drop out problem. The frequency response is wide, the sound quality is rich and full, with strong vocal expression. cardioid directional pickup, high sensitivity, while reducing environmental noise. The tone is high fidelity. It is suitable for karaoke, bars, night clubs, KTV and other entertainment venues.

Key Features:

- Adopt true diversity FM super-heterodyne reception to ensure the stability of the received RF signal and the anti-interference of the receiver itself; the operating frequency range is from 522MHz to 936MHz .
- The receiver comes with the electronic volume adjustment, the adjustment range is -6dB to +18dB, +3dB step.
- The receiver is equipped with a elegant large LCD display and clearly display the receiving channel, RF and AF signal strength.
- Channel group mode is selected, and 50 channel groups in each frequency band provide user selection.
- 128MHz wideband transmitter, four different frequency band receivers can be used interchangeably, which greatly facilitates KTV debugging and management.
- With [IR] infrared automatic frequency matching function, press the [SYNC] button, the transmitter can automatically and accurately lock the working frequency of the receiver.
- AFS Automatic frequency selection. Press the [AFS] (Auto Frequency Selection) button 3S and the receiver will auto-scan and lock on to an open, interference-free frequency.
- Matching the Relacart's classic audio companding circuit to minimize the noise from the transmission of radio waves, and to ensure the maximum pickup effect of the product in use
- The receiver can display the battery level of the transmitter and can change according to the battery level of the transmitter.
- The BNC antenna can be connected to the coaxial antenna and the extended antenna, and provides the antenna power supply voltage. It can be connected to the Relacart classic Antenna distribution system, expand the multi-device, enhance the receiving distance and improve the signal stability.

03 Receiver Installation Method

Installation:

- ① For better operation the receiver should be at least 3ft (1m). above the ground and at least 3ft (1m). away from a wall or metal surface to minimize reflections.
- ② Attached a pair of UHF antennas to the antenna input jacks, the antenna are normally positioned in the shape of a " V " (both 45° from vertical) for best reception.
- ③ Keep antennas away from noise sources such as computer, digital equipment, motors, automobiles and neon lights, as well as away from large metal objects
- ④ Keep open space between the receiver and transmitter for better reception.
- ⑤ The transmitter should be at least 6ft (2m). from the receiver

04 Packing List

ER-5700:

- ◆ Wireless microphone receiver *1
- ◆ Wireless transmitter *2
- ◆ BNC Antenna *2
- ◆ External power adapter * 1
- ◆ 1 meter audio cable *1
- ◆ 1.5V AA battery *4
- ◆ 1 U rack mount kit (screw) * 1 set
- ◆ Installation and operation * 1

ER-5900:

- ◆ Wireless microphone receiver *1
- ◆ Wireless transmitter *2
- ◆ BNC Antenna *2
- ◆ External power adapter * 1
- ◆ 1 meter audio cable *1
- ◆ 1.5V AA battery *4
- ◆ 1 U rack mount kit (screw) * 1 set
- ◆ Installation and operation * 1

(ER-5700)



(ER-5900)

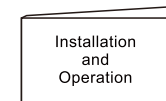
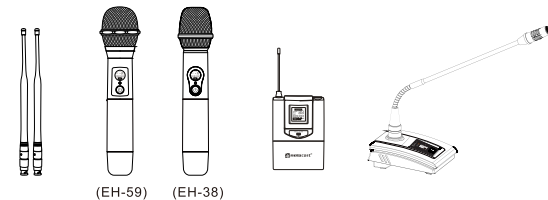

05 Receiver Front Panel Function Introduction

(ER-5700)

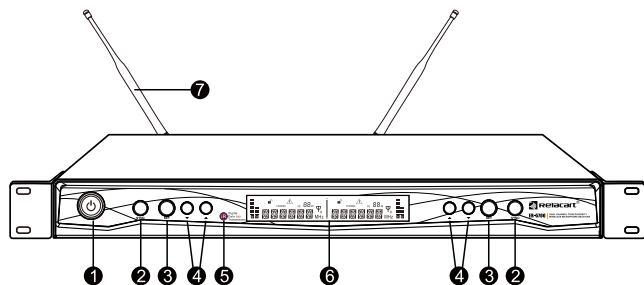

(ER-5900)

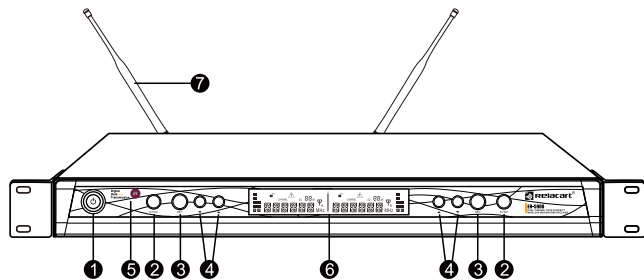

- 1 Power switch: Turn on the receiver of power supply, long press to turn off the receiver.
- 2 "SYNC" button: When the infrared frequency window of the receiver and transmitter is aligned, press the "SYNC" button, synchronization of transmitters via IR interface from receiver.
- 3 "SET" button: Press to step through menus, choose operating frequency and select receiver function options.
- 4 "▲/▼" allow control button: Press the allow button to edit the menu parameter values; Long press "▼" button to enter [AFS] auto- scan function and the receiver will auto- scan and lock on to an open, interference-free frequency.
- 5 Infrared data transfer window (IR) : Transmit channel data from the receiver to the transmitter, so that they are in the same frequency, in order to realize the synchronization.
- 6 LCD display: Display working channel or frequency, RF/AF, diversity strengths, transmitter battery level, mute and operation menu.
- 7 1/2 wavelength BNC antenna: Used to receive radio transmitter for transmission.

06 Receiver Rear Panel Function Introduction

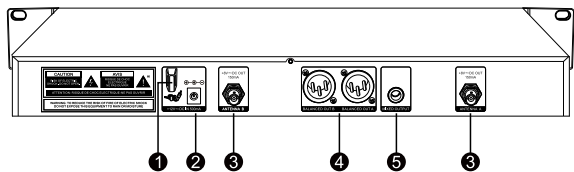

- ❶ RF antenna diversity BNC input connector: suitable for connection of antenna A and antenna B, and supports DC 8V/150mA power output.
- ❷ Anti-pull device: used to fix the connecting cable of the external power adapter.
- ❸ DC IN socket: connect to external power adapter.
- ❹ Balanced audio output port (dual channel independent): The XLR port can be used to connect a standard 2 conductor shielded cable the receiver output to a balanced microphone level input on a mixer.
- ❺ Unbalanced audio output port (dual channel mixed): The 6.3mm port can be connected to the microphone or line input of the device.

07 Transmitter Function Introduction

Handheld microphone (EH-38)

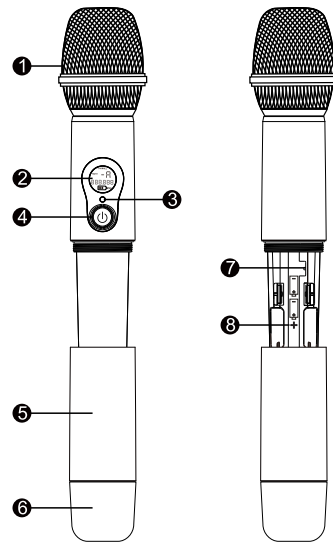

Handheld microphone (EH-59)

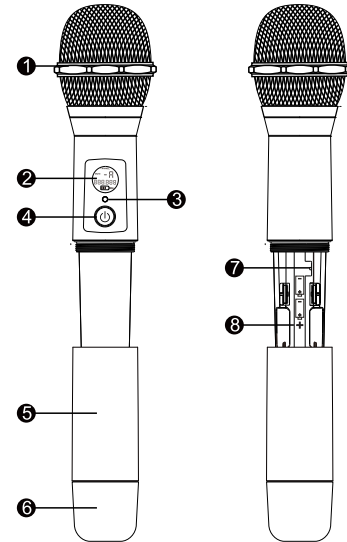

- ❶ Microphone Head: It is the important part to transfer sound into audio signal. The microphone head is separate to change other microphone head if needed.
- ❷ LCD display: display the frequency, channel, mute and battery life. Battery indicator displays a maximum of 4 bar segments. When it leaves 1 bar segment, the batteries should be replaced immediately.
- ❸ Infrared data receiving window (IR): Synchronization of transmitters via IR interface from receiver.
- ❹ Power Button/Mute Button: Press the power button to turn on the transmitter, press the power button 1.5 second enter the mute status, press one more time to close the mute function. Long press 3 seconds to turn off the transmitter.
- ❺ Battery cover: Unscrew it can reveal the battery compartment; When installing or replacing, the battery cover must be opened.
- ❻ Handheld transmitter tail cover: integrated antenna transmission output port.
- ❼ RF power switch: HI is 40 mW, LO is 10 mW.
- ❽ Battery compartment: Insert 2 fresh 1.5V AA batteries. (Alkaline type is recommended. Please remember to replace both batteries.)
Warn: Observe correct polarity as marked inside the battery compartment to avoid damage to the internal electric parts.

Bodypack microphone (ET-50)

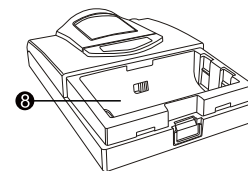
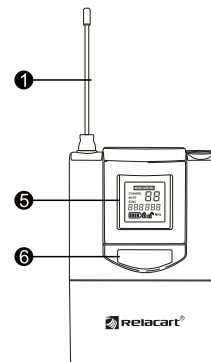
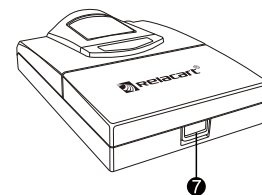
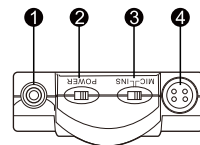

- ❶ Antenna: For transmitting a bodypack radio carrier.
- ❷ Power toggle switch: Toggle this switch to turn on or off power supply of the transmitter.
- ❸ AF/INS audio input selection switch: The transmitter can be connected with an audio input device (microphone or instrument connection cable) at the top part-the input socket. "MIC" is used for microphone input and "INS" is used to connect to guitar with instrument connection cable.
- ❹ 4-pin mini XLR plug: Connect to 4-pin lavalier microphone or instrument cable.
- ❺ LCD display: display the frequency, channel, lock and battery life. Battery indicator displays a maximum of 4 bar segments. When it leaves 1 bar segment, the batteries should be replaced immediately.
- ❻ Infrared data receiving window (IR): Synchronization of transmitters via IR interface from receiver.
- ❼ Battery Door Switch: Open the battery door by sliding the switch.
- ❽ Battery Compartment: Pull to open the battery door and insert 2 fresh 1.5V AA batteries. (Alkaline type is recommended. Please remember to replace both batteries.)
Warn: Observe correct polarity as marked inside the battery compartment to avoid damage to the internal electric parts.

Desktop gooseneck microphone (UD-2)

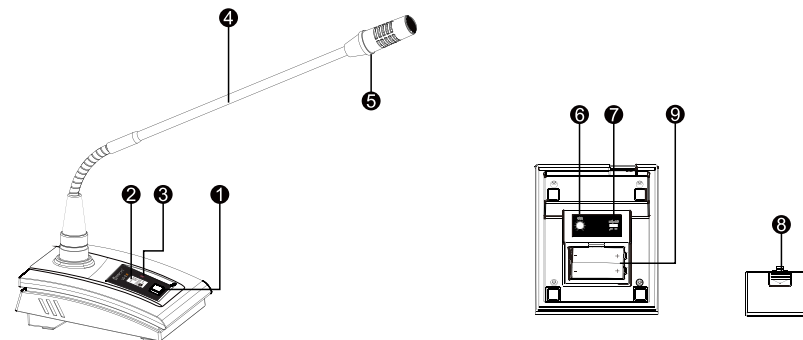

- ❶ Power Button/Mute Button: Press the power button to turn on the transmitter, press the power button 1.5 second enter the mute status, press one more time to close the mute function. Long press 3 seconds to turn off the transmitter.
- ❷ LCD display: Display the frequency, channel, lock and battery life. Battery indicator displays a maximum of 4 bar segments. When it leaves 1 bar segment, the batteries should be replaced immediately.
- ❸ Infrared data receiving window (IR): Synchronization of transmitters via IR interface from receiver.

08 Transmitter Battery Installation

- ④ Microphone rod: bending gooseneck design, can flexibly put the pickup head to any position.
 - ⑤ Speaking Aperture: When you open the microphone to speak, this instruction light bright.
 - ⑥ Gain knob: adjust the input signal size.
 - ⑦ Low cut switch: cut off the low-frequency signal below 150Hz.
 - ⑧ Battery Door Switch: Open the battery door by sliding the switch.
 - ⑨ Battery Compartment: Insert 2 fresh 1.5V AA batteries. (Alkaline type is recommended. Please remember to replace both batteries.)
- Warn: Observe correct polarity as marked inside the battery compartment to avoid damage to the internal electric parts.

(EH-38)

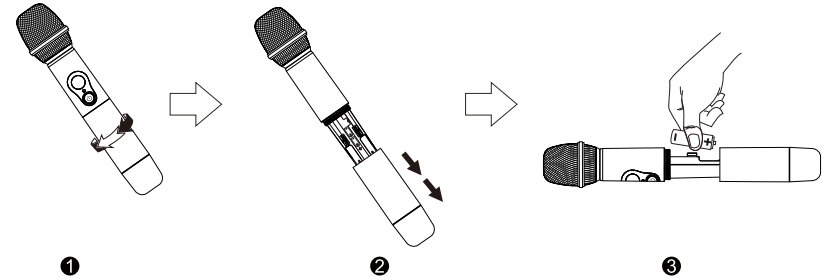

(EH-59)

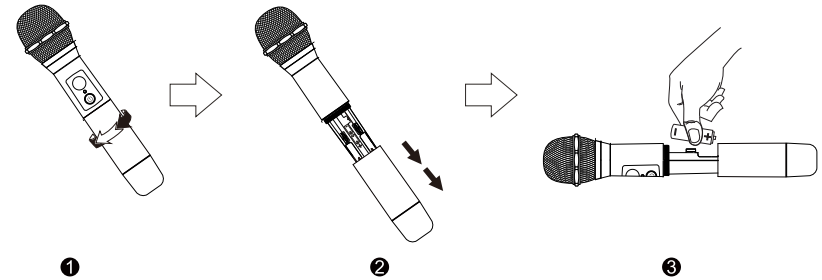

09 System Setup

(ET-50)

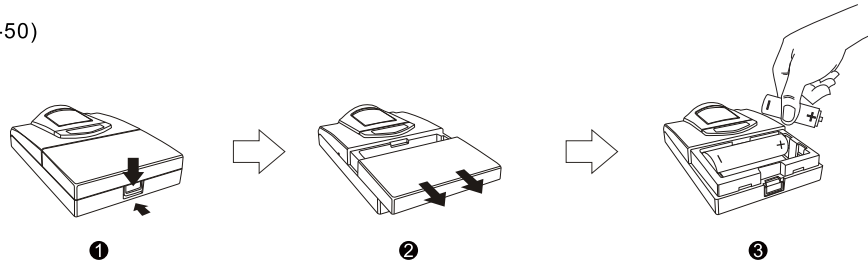

(UD-2)

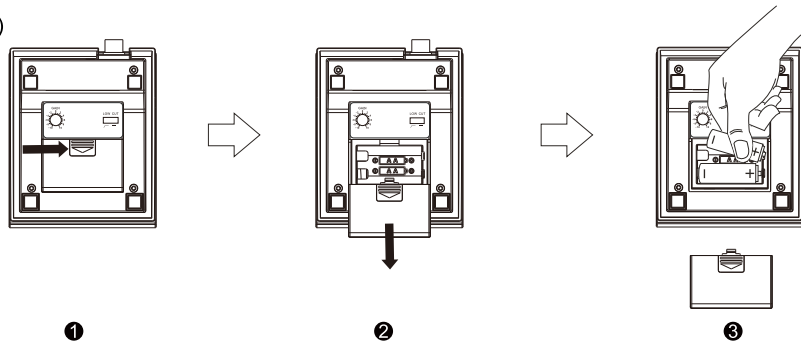

Receiver Setup

1. Make sure the transmitter is off before turning on the receiver.
2. Press the power switch on the receiver, LCD backlight will turn bright, and the normal display will be in 1-2 seconds. If the screen shows more than two signals, which means that there is a frequency interference from outside, please change the other operating frequency.
3. Change the operating frequency by manual or by auto-scan mold:
 - a) Set the operating frequency by manual: press ▲/▼ to change the frequency, after the selected frequency flashes 4 times, the receiver will enter the selected frequency and show it on the LCD screen.
 - b) AFS Auto Frequency Scanning: long press ▲/▼ or 3 seconds, the receiver will auto scan about 30 seconds and lock on to an interference-free frequency.
4. Enter the main menu: long press SET button 3 seconds to enter the main menu. Press ▲/▼ button to select the following menu: SQUELCH (squelch level control: 10 ~ 40dB), LEVEL (electronic volume adjustment: -06 ~ +18dB), R-LOCK (lock operation) and REVISI (display version).
 - (1) **SQUELCH (squelch level control)**: Selecting "SQUELCH", then touch SET Button to enter edit mode, the small data flashes to indicate edit, touch ▲/▼ button to scroll through the available choice for the function. The squelch level is adjustable in every 5dB steps, providing a 10dB ~ 40dB range. Press SET Button to confirm the desired choice, then LCD return to its previously displayed contents. Finally press "SET" to confirm.

(Receiver squelch threshold is factory preset. When the transmitter too far away from the reception range or receiver does not receive enough transmit power, you can adjust by yourself. Note that unless absolutely necessary, please do not adjust the squelch threshold, if adjusted too low will produce excessive noise, system operation will not stable.)
 - (2) **LEVEL (electrical level adjustment -06 ~ +18dB)**: select LEVEL, then press SET to enter the edit mode, press ▲/▼ button, the adjustable electronic volume (-06 ~ +18dB). Finally press SET to confirm.

10 User simple steps

(3) R-LOCK (lock operation): select “R-LOCK”, then touch SET Button to enter edit mode, touch ▲ arrow button, it displays “ON”, if stopping on “ON”, the system enters lock mode, the user can not use any button for any control; touch ▼ arrow button, it displays “OFF”, if stopping on “OFF”, the user can do any control by any button.

Press SET (LOCK ON)status, long press SET button 3 seconds, press ▲/▼ button to select LOCK, then press ▼, the screen refreshes OFF, finally press SET to confirm, the lock status is released.

(4) REVISI (display version): select “REVISI”, then press SET to enter version mode, display current version information.

Operating menu of the Receiver:

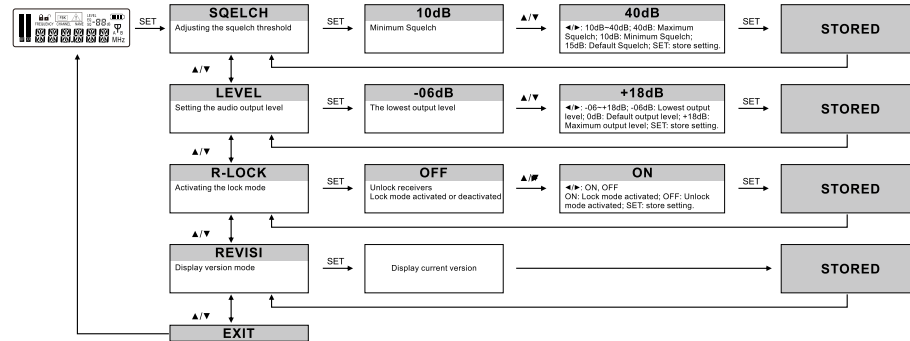

1. After connecting the antenna and the power cable, press the power button to turn on the receiver. When the display is lit, the power is turned on successfully. (As shown below)

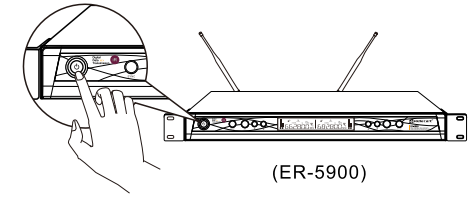
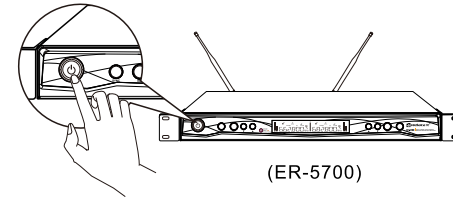

2. Long press “●” button on the receiver to enter Automatic Frequency Search (AFS) function. (As shown below)

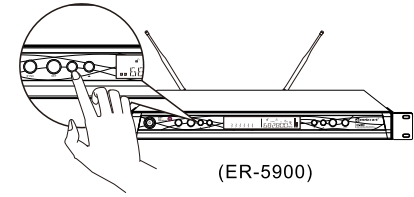
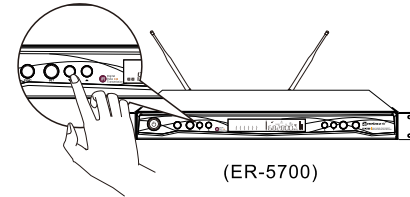

The searched channel automatically calculates the interference-free frequency. The “RF” light on the receiver display is 0 grid. If not, you can repeat this action until a clean channel is found. (As shown below)

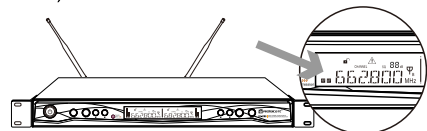

(ER-5700)

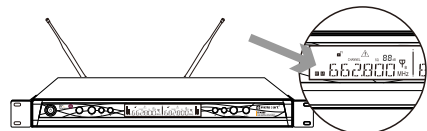

(ER-5900)

3. The transmitter's infrared window facing to the receiver IR port. Press the “SYNC” button. (As shown below)

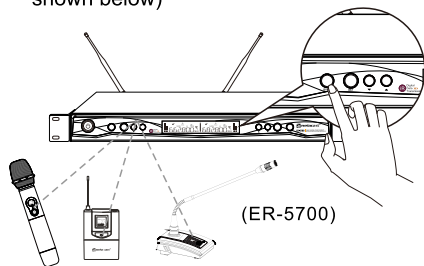

(ER-5700)

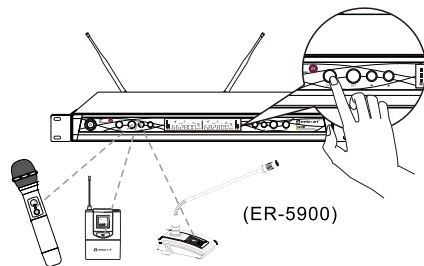

(ER-5900)

Frequency alignment < 15cm (6 in)

The frequency of the transmitter and the receiver are synchronized. When talking with the microphone, the “AF” signal in the display jumps to indicate that there is an audio output. (As shown below)

(ER-5700)

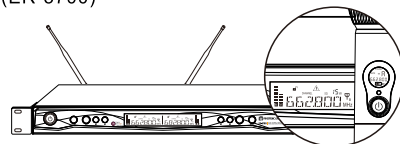

(ER-5900)

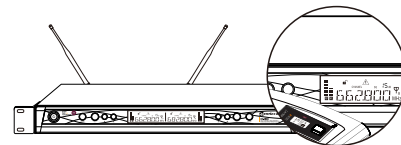
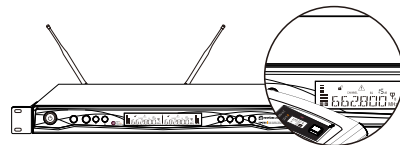
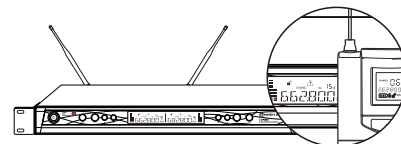
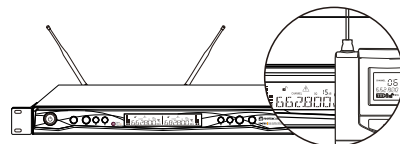
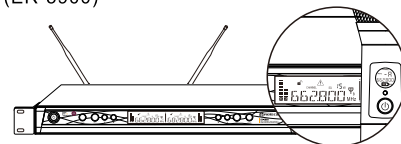

Channel display (receiver and transmitter display the same frequency)

11 Technical Specification

ER-5700, ER-5900 Dual Channel Receiver

Main Frame Size:	EIA standard 1U
Receiving Channel:	Dual Channel
Frequency Stability:	±0.005% (-10° C ~ 50° C)
Carrier Frequency Range:	522MHz ~ 936MHz
Receiving Mode:	FM Superheterodyne true diversity reception
RF Sensitivity:	5dBμV, S/N>60dB at 25 deviation
Squelch:	10dB to 40dB, 5dB step
Frequency Sync:	IR Sync
Max. Output Level:	Maximum output + 11dBV
Adjustment Range of Audio Output Level:	-6dB to +18dB, 3dB step
Power Supply:	DC12V/1A
Current Consumption:	DV12V, 330mA
Dimension (mm):	410 (W) x 206 (D) x 43 (H)
Weight:	Approximately 1.8Kg

EH-38, EH-59 Handheld Microphone

Carrier Frequency Range:	522MHz ~ 936MHz
Oscillation:	PLL Synthesized
RF Output Power:	5mW/30mW
Carrier Deviation:	0.5KHz
Harmonic Radiation:	≤45dB
Modulation Mode:	FM
Nominal/ Peak Deviation:	±45KHz
Max. Input Level:	Maximum input - 11dBv
Frequency Set-Up:	IR Sync
Battery:	AA x 2
Battery Current/Life:	Approximately 8 hours
Dimensions (mm):	50 (Φ) x 260 (L)
Weight:	Approximately 330g (w/o battery)

ET-50 Bodypack Transmitter

Carrier Frequency Range:	522MHz ~ 936MHz
Oscillation:	PLL Synthesized
RF Output Power:	5mW/30mW
Carrier Deviation:	0.5KHz
Harmonic Radiation:	≤45dB
Modulation Mode:	FM
Nominal/ Peak Deviation:	±45KHz
Max. Input Level:	Maximum input - 11dBv
Frequency Set-Up:	IR Sync
Battery:	AA x 2
Battery Current/Life:	Approximately 8 hours
Dimensions (mm):	95 (H) x 65 (W) x 25 (D)
Weight:	Approximately 80g (w/o battery)

UD-2 Desktop Gooseneck Microphone

Carrier Frequency Range:	522MHz ~ 936MHz
Oscillation:	PLL Synthesized
RF Output Power:	10mW / 25mW
Carrier Deviation:	0.5KHz
Harmonic Radiation:	≤45dB
Modulation Mode:	FM
Nominal/ Peak deviation:	<45KHz
Gain Adjustment Range:	-10dB ~ +10dB
Frequency Set-Up:	IR Sync
Battery:	AA x 2
Battery Current/Life:	Approximately >8 hours
Dimensions (mm):	Microphone base: 141 x 115 x 48
	Microphone tube: 430mm
Weight:	Approximately 1Kg (w/o battery)